



## **MECHANICAL NAILER**

<b>MEMBERS' NAME</b>	<b>REGISTRATION NUMBER</b>
<b>NURUL IZZATI BINTI ABDUL RAZAK</b>	<b>08DKM18F1070</b>
<b>HAIQAL HAFIYFY BIN HUZAIMI</b>	<b>08DKM18F1076</b>
<b>SITI AISHAH BINTI ABDULLAH</b>	<b>08DKM19F1250</b>

**DEPARTMENT OF MECHANICAL  
ENGINEERING**

**JUN 2020**

**POLITEKNIK SULTAN SALAHUDDIN ABDUL AZIZ SHAH**

**MECHANICAL NAILER**

<b>MEMBERS' NAME</b>	<b>REGISTRATION NUMBER</b>
<b>NURUL IZZATI BINTI ABDUL RAZAK</b>	<b>08DKM18F1070</b>
<b>HAIQAL HAFIYFY BIN HUZAIMI</b>	<b>08DKM18F1076</b>
<b>SITI AISHAH BINTI ABDULLAH</b>	<b>08DKM19F1250</b>

**This report is submitted to the Department of Mechanical  
Engineering to fulfil the condition in the Mechanical Engineering  
Diploma**

**DEPARTMENT OF MECHANICAL ENGINEERING**

**JUN 2020**

## **DECLARATION OF ORIGINALITY AND COPYRIGHT**

This is to certify that to the best of our knowledge, the content of this work is our own work. This report has not been submitted for any work or other purposes. We declare that the intellectual content of this report is the product of our own work and that all the assistance received in preparing this report and sources have been acknowledged.

Lecturer's Name : PUAN ASNIZAH BINTI SAHEKHAINI

Signature : \_\_\_\_\_

Date : \_\_\_\_\_

### **NAME**

NURUL IZZATI BINTI ABDUL RAZAK

Signature : \_\_\_\_\_

HAIQAL HAFIYFY BIN HUZAIMI

Signature : \_\_\_\_\_

SITI AISHAH BINTI ABDULLAH

Signature : \_\_\_\_\_

Date : \_\_\_\_\_

## **ACKNOWLEDGEMENT**

We are thankful to the divine presence because with His bounty, we can complete our task within the allotted time. Therefore, we would like to take this opportunity to thank all those involved either directly or indirectly as we carry out this task. Our deepest appreciation to all parties involved in providing financial contributions, ideas, information and encouragement for us to complete this final year project report. We would also like to thank the Sultan Salahuddin Abdul Aziz Shah Polytechnic, especially the Department of Mechanical Engineering, for giving us the opportunity to apply the knowledge learned in producing our final year project.

In addition, we thank Mrs. Asnizah Binti Sahekhaini as our supervisor who gave a lot of guidance and advised us in the process of completing our final year project. Not forgetting our parents who provide financial and moral support. To all the friends who helped directly and indirectly, many thanks also for having helped and collaborated in completing this project.

Thank you.

## **ABSTRACT**

The mechanical nailer is a tool that is specially designed to facilitate work involving wood nailing. The main problem that often occurs in nailing is regarding to safety issues. The use of a regular hammer in nailing work often causes injury to the user especially for those who are inexperienced in hammering. Injuries often occur in the hands, more specifically the fingers. This is because their fingers are exposed to the hammer when they want to hammer. Therefore, the objective of this tool is to reduce the risk of injury when hammering by converting the use of a regular hammer to a mechanically functioning hammer and preventing the fingers from being exposed to the hammer. The use of this tool is also easy because the user just needs to insert the nail into the holder and pull and release the rod until the nail goes into the wood. The results of the study were obtained by using the method of questionnaires to the public on the issue of nailing .The improvement made is that this carpentry equipment is designed to prevent injuries to the fingers and the effective design makes this tool small as well as light and easy to use. Due to its portable design, this tool can be easily carried and stored.

## **ABSTRAK**

Pemaku mekanikal ialah alat yang direka khas untuk memberikan kemudahan kepada kerja-kerja yang melibatkan pemakuan kayu. Masalah utama yang sering berlaku dalam menukul ialah berkenaan dengan isu keselamatan. Penggunaan penukul biasa dalam kerja-kerja memaku sering mendatangkan kecederaan kepada pengguna lebih-lebih lagi bagi mereka yang tidak berpengalaman dalam menukul. Kecederaan sering berlaku di bahagian tangan, lebih spesifik lagi di jari. Hal ini berlaku kerana jari mereka terdedah kepada penukul semasa mereka ingin menukul. Oleh itu, objektif alat ini ialah untuk mengurangkan risiko kecederaan ketika menukul dengan menukarkan penggunaan tukul biasa kepada tukul yang berfungsi secara mekanikal dan mengelakkan jari daripada terdedah kepada tukul. Penggunaan alat ini juga mudah kerana pengguna hanya perlu memasukkan paku ke dalam alat ini dengan menarik dan melepaskan rod sehingga paku masuk ke dalam kayu. Kajian telah dijalankan terlebih dahulu sebelum melaksanakan projek ini dan hasil daripada analisis tersebut digunakan bagi menyiasat ciri-ciri yang diperlukan untuk menghasilkan alat tersebut. Hasil daripada kajian diperoleh dengan menggunakan kaedah soal selidik kepada orang awam tentang isu berkenaan memaku. Penambahbaikan yang dibuat ialah peralatan pertukangan ini direka untuk mengelakkan kecederaan pada jari dengan rekaanya yang efektif membuatkan alat ini kecil serta ringan dan mudah untuk digunakan. Oleh kerana reka bentuknya yang mudah alih, alat ini dapat dibawa dan disimpan dengan mudah.

## LIST OF CONTENTS

CHAPTER	TITLE	PAGE
	DECLARATION OF ORIGINALITY AND COPYRIGHT	3
	ACKNOWLEDGEMENT	4
	ABSTRACT	5
	ABSTRAK	6
<b>1</b>	<b>INTRODUCTION</b>	
	1.1 INTRODUCTION	13
	1.2 PROBLEM STATEMENT	14
	1.3 OBJECTIVES OF STUDY	15
	1.4 SCOPE OF STUDY	15
	1.5 SIGNIFICANCE OF STUDY	16
	1.6 CHAPTER SUMMARY	16
<b>2</b>	<b>LITERATURE REVIEW</b>	
		17
	2.1 INTRODUCTION	18
	2.2 HAMMER	19
	2.3 BOW	20
	2.4 SPRING	21
	2.5 NEOPRENE RUBBER SHEET	22
	2.6 METAL INERT GAS (MIG)	23
	2.7 STAINLESS STEEL	24

2.71 STAINLESS STEEL FLAT BAR	25
2.72 STAINLESS STEEL ROD	26
2.8 CHAPTER SUMMARY	

### **3 METHODOLOGY**

3.1 INTRODUCTION	27
3.2 FLOW CHART	28
3.3 PROBLEM STATEMENT	29
3.4 FEATURES	29
3.5 REQUIREMENT ANALYSIS	30
3.6 DESIGN	32
3.7 WORKING PROCEDURE	35
3.7.1 MEASURING AND CUTTING	35
3.7.2 GRINDING	36
3.7.3 DRILLING	37
3.7.4 WELDING	37
3.7.5 ASSEMBLY	38
3.8 PRODUCT TESTING	39
3.9 CHAPTER SUMMARY	40

### **4 RESULT AND DISCUSSION**

4.1 INTRODUCTION	41
4.2 DESIGN ANALYSIS	42
4.3 RESULT	46
4.4 ADVANTAGES	47
4.5 DISADVANTAGES	47
4.6 PRODUCT DESCRIPTION	48
4.7 COSTING	49
4.8 CHAPTER SUMMARY	50



**CONCLUSION**

5.1 INTRODUCTION	51
5.2 PROBLEMS AND CHALLENGES	51
5.3 SOLVING PROBLEMS	52
5.4 OTHER PROBLEMS	52
5.5 CONCLUSION	53
5.6 CHAPTER SUMMARY	53
<b>REFERENCES</b>	<b>54</b>

## LIST OF FIGURES

NO.	TITLE	PAGE
2.0	HAMMER	18
2.1	BOW	19
2.2	SPRING	20
2.3	NEOPRENE RUBBER SHEET	21
2.4	MIG MACHINE	22
2.5	STAINLESS STEEL FLAT BAR	24
2.6	STAINLESS STEEL ROD	25
3.0	FLOW CHART	28
3..1	DESIGN 1	32
3.2	DESIGN 2	33
3.3	DESIGN 3	34
3.4	VERNIER CALIPER	35
3.5	CUT – OFF SAW	35
3.6	SURFACE GRINDER	36
3.7	HAND GRINDER	36
3.8	BENCH DRILL	37
3.9	MIG MACHINE	38
4.0	AGE	42
4.1	GENDER	42
4.2	QUESTION 1	43
4.3	QUESTION 2	43
4.4	QUESTION 3	43
4.5	QUESTION 4	44

4.6	QUESTION 5	44
4.7	QUESTION 7	44
4.8	QUESTION 7	45
4.9	QUESTION 8	45
4.10	QUESTION 9	45
4.11	MECHANICAL NAILER	48

## LIST OF TABLES

<b>NO.</b>	<b>TITLE</b>	<b>PAGE</b>
3.0	PRODUCT TESTING	39
4.0	RESULT	46
4.1	COSTING	49

# CHAPTER 1

## INTRODUCTION

### 1.1 INTRODUCTION

Nailing is one of the most well-known activity in work related to wood. Nailing is a very important form of bonding in wood work and is usually done using nails and hammer. Although hammers are a well-versed tool in many industries, it is one of the tools that are easy to use but are also very easy to injure yourself with when used. Using the traditional method such as using a hammer in nailing is a common yet hazardous way of nail work. Therefore, before jumping into any project or using a tool, often for the first time, it is vital to make safety a top priority. Taking the proper safety measures not only protects yourself, but also those around you and your home. In workplace environment, the cost of injury prevention is far less than the cost of an injury. A safe and healthy workplace attracts and retains quality employees. It is an asset to a community, operates more efficiently and enjoys a healthy bottom line. The business and the workers thrive in a safe, healthy, respectful and caring environment. Therefore, we can see how important safety is in our lives especially in the workplace. As a result, the Mechanical Nailer is created to help people nail safely and prevent any injuries or accidents relating to nailing during usage. The Mechanical Nailer is a fully manual tool and does not require electricity such as a nail gun in order for it to function properly. The user only has to put the nail in the holder and pull the handle on the rod and let go. The force from the spring will push the rod and put force on the surface of the nail. This project is easy to use and highly affordable for a wide range of people. Although, it could be used by anyone, the Mechanical Nailer is targeted for carpenters and beginners in softwood nailing. The design of the product which is considered safer than a regular hammer does not leave the fingers vulnerable to an

accidental hit. The simplicity of design makes it easy to be produced and manufactured. Although, the hammer is an excellent tool in everyday work, the mechanical nailer is recommended to people who nail wood regularly and prioritize safety in their life.

## **1.2 PROBLEM STATEMENT**

The hammer is a very common tool that is used by a wide range of people. Hammers and nails are commonly used in many industries, and they are also used in the home [1]. It is easy to use and serves its purpose in nailing. However, there is also a big factor that should be considered in nailing which is safety. The fact that hammers are a common tool that is used means that there was also a lot of accidents that had been caused during its usage. Especially for beginners who are inexperienced with wielding a hammer, they could cause injuries to themselves and other people. Experienced people can also have a problem in using hammers sometimes. For example, an unfortunate incident occurred to an employee at a construction site in Fremont at 1 :30 p.m. on December 22 ,1997 when a nail bounced back into his eye when he nailed the frames with a glancing blow. He was diagnosed as having sustained a full cornea thickness laceration and a traumatic cataract, with a fluffed-up cortex [2]. There was also an incident in which a member of the IMCA ( INTERNATIONAL MARINE CONTRACTORS ASSOCIATION) has reported an incident in which a wooden hammer shaft failed and the head fell to deck. There were no injuries. Had the falling hammer head struck a person, according to the DROPS calculator it would have caused a fatality [3]. Also, a popular singer in the 90's named MC Hammer says 'You can hit your fingers. So I try my best to not have to hammer too many things.' [4]. This shows that there are people who refuse to work using hammers because they are concerned with the potential harm that they may cause to themselves and the lack of safety in using the hammer. To solve the problem of the hazardous situation that the hammer may cause, the Mechanical Nailer is designed. It is invented to replace the use of hammers specifically in softwood carpentry. The Mechanical Nailer is user friendly and easy to use. It is also safer for nailing in daily life. Therefore, it is the best option for people who have to nail wood regularly and are conscious of their safety.

### **1.3 OBJECTIVES OF STUDY**

The objectives of this project are :-

#### **Design**

- i. To design a hand tool that could help people nail wood safely and easily.

#### **Fabricate**

- ii. To fabricate a tool that could help in the productivity and health of people related to nailing.

#### **Test**

- iii. To test the effectiveness and limitations of the project in nailing wood.

### **1.4 SCOPE OF STUDY**

The scope and limitation of the study are :-

- i. The study is focused on carpenters and people who are inexperienced with hammers.
- ii. The level of safety in nailing using a regular hammer.
- iii. The tool will be a safe option for nailing wood.
- iv. The tool is limited to softwood usage only because of the force is limited based on the strength of the person.
- v. The project is a fully manual hand tool and requires human force in operation.

## **1.5 SIGNIFICANCE OF STUDY**

The significance of this study is to develop a properly and useful working tool that could help people to nail wood safely and prevent any accidents during nailing. It is also significant in improving the way people are nailing wood by doing an innovation of the hammer. There have been many innovations of the hammer which is a common tool in wood work. There are a lot of tools that are related to nailing and some of them are very excellent improvement of the hammer. This study is one of the many studies that would help people in making a better decision in nailing with the option of safety. Research is an important step to do before making something especially a project or tool that is related to safety and is used by a wide range of people. Not engaging in the act of research before proceeding with a project or an idea could be fatal and leads to various casualties. That is why it is necessary to perform research in a study. This study could potentially contribute in making a better tool for nailing. Future researches could use this study as a source of idea or analysis in making a better tool for nailing by expanding its function. Therefore, this study is important and could contribute a lot to the society if it is deemed successful in the application and reach the objectives that have been set initially.

## **1.6 CHAPTER SUMMARY**

The first chapter of this study informs about the project and a brief explanation of it. It is then followed by the objectives which have been selected in the beginning of the study. This chapter further describes the factors which lead to this study through the problem statement and is followed by the scope of study and significance of study which explains the range and importance of this study.



## **CHAPTER 2**

### **LITERATURE REVIEW**

#### **2.1 INTRODUCTION**

The hammer is one of the commonly used tool and nevertheless an excellent tool to use. It is a simple yet useful tool. However, because of the tool lacking in the safety department, this study is done in order to overcome the problem. The process of doing research in creating an exceptional tool is a very important step. Therefore, the study will revolve around the things that should be considered before executing the project such as the materials, mechanisms and properties that are important in having a proper working project. The initial idea of making the Mechanical Nailer is to produce a tool that could help people nail into wood safely and reduce injuries, especially accidents involving the fingers. So, the proper materials and mechanism should be selected in order to achieve that goal. The force that will be required to ensure that the nail will get into the wood is also an important aspect to be considered in the study. Thus, the selection of mechanism of the tool plays a crucial part in making sure that the tool could function properly and fulfil the objective that has been set initially. Mechanisms allow us to understand complex systems and can help us to explain, predict, and intervene. In engineering, a mechanism is a device that transforms input forces and movement into a desired set of output forces and movement. Mechanisms generally consist of moving components that can include gears and gear trains, friction devices, such as brakes and clutches and also structural components such as a frame, bearings, springs, and lubricants [5]. In this study, the things that are related to hammering, nailing and wood work are being considered. However, the study in wood work will only be specified to softwood such as pine wood because of the limitations that has been set. Indeed, the process of studying for the different aspects of the

project is an important step in making sure that the outcome of the project will be the same that has been visualized from the start.

## 2.2 HAMMER



**Figure 2.0 : Hammer**

A hammer is a simple tool designed to manually drive nails, brads, and other fasteners into softer materials, such as wood or drywall. The components of the head depend on the type and use of the hammer, but most have a face that strikes the fastener behind the bell and neck, which holds the handle. The opposite end of the head may have a forked nail-puller (called a claw hammer) or a peen (small face for driving pins or tacks) [6]. There are various types of hammers such as ball peen, sledge hammer, cross peen pin hammer and club hammer. However, the commonly used hammer is the claw hammer. The claw hammer is popular amongst carpenters and workshop related work. The claw is normally curved, and incorporates a 'V' cut-out to draw nails from timber. The claw can be used to lever up floorboards or where other places where a lever is required; care must be taken (especially with cheaper models) as the force applied can easily weaken the joint between the handle and the head [7]. The hammer is observed to obtain the advantages and disadvantages that could be used to incorporate in the project. The flaws that are acquired from the hammer is recorded for reference to improve the existing tool.

## 2.3 BOW



**Figure 2.1 : Bow**

A bow is basically a weapon that is used for shooting arrows [8]. Humans used bows and arrows for hunting and violence long before recorded history, and the practice was common to many prehistoric cultures. They were important weapons of war from ancient history until the early modern period, where they were rendered increasingly obsolete by the development of the more powerful and accurate firearms, and were eventually dropped from warfare. Today, bows and arrows are mostly used for hunting and sports [9]. A bow works the same way a spring does. The moment the bowstring is pulled back, the potential energy is stored in the flexing limbs of the bow. The instant the string is released, all of the stored energy is transferred instantly into the arrow, sending it flying down range. The action exerted the energy over more time, storing it in the bow, and then only using the lightweight string to push the arrow, more power is transferred into the arrow. Thus, by observing the bow, the working mechanism of the bow could be applied in the project by substituting the bowstring to a spring. The working mechanism of the bow is an easy concept to understand and apply. It is also similar to the idea of the project initially to create a tool that could provide enough force to make the nail go into the wood without having to use too much energy safely.

## 2.4 SPRING



**Figure 2.2 : Spring**

Springs are mechanisms that have the capacity to absorb, store and release energy through a change in shape [10]. There are many types of springs such as compression springs, extension springs, torsion springs and constant force springs. Tension springs and compression springs look similar therefore it is understandable to confuse the two, however they are actually designed to do very different things. Compression springs are helically coiled wires designed to provide an opposing force when compressed. Under increasing load, the space between coils closes until the spring's compressed length is reached, when the coils touch. Compression springs can be used for engines, major appliances, tools, lawn mowers, medical instruments, electronics, cell phones—down to a simple pen. Anything that requires stored energy within the spring [11]. Extension springs are helically coiled wires designed to provide an opposing force when stretched. Key specifications include the spring rate, helix type, spring ends type, wire diameter, material, and free and maximum extended lengths. Extension springs are used primarily in manufacturing applications where a variable, opposing force is required between two components [11]. Extension springs can also be used in vehicles, garage doors, trampolines, outdoor furniture, machinery and tools like vise-grip pliers. Extension spring is the perfect type of spring to be used in the project because of the mechanism that the tool uses is somewhat similar to the bow which requires the spring to stretch when being pulled and returns to the original form when it is released while producing more force than applied. The compression spring requires more energy to be used and is not suitable because of its lack of elasticity.

## 2.5 NEOPRENE RUBBER SHEET



**Figure 2.3 : Neoprene Rubber Sheet**

Neoprene Rubber Sheet have outstanding adhesion to metal surfaces and is available in a variety of choices depending on specific gravity, hardness, chloroprene content, mechanical properties and surface finish as well [12]. It has excellent resistance to any kind of impact and abrasions and also has good elastic properties. The rubber has superb weathering and ozone resistant properties as well as being suitable for use with greases, inorganic salts, acids, water and oils. This means that it is ideal for a whole range of outdoor uses, particularly where there is extensive exposure to water and the weather. Because of these qualities, Neoprene is also used for applications such as corrosion-resistant coatings and landfill linings. Rubber in general is known for flexibility, resistance, and strength, but neoprene is especially known for its weather and flame resistance. Both natural and artificial rubber is known for its elasticity, electrical insulating properties, and resistance to impact, water, cold, and abrasion. Using a material such as neoprene rubber sheet is one of the ways to absorb great impact, reduce noise emission, and resist severe abrasion. When the goal is reducing the shock and damaging vibration of severe impact, rubber maximizes the life of equipment and dramatically decreases the cost. Noise pollution is a key consideration of the environment and for people working on and living around job sites. Therefore, using a shock absorbing sheet such as neoprene rubber sheet is not only a good option in reducing the impact that will be caused between the body and rod but also reduces wear time and noise that will be produced during usage.

## 2.6 METAL INERT GAS (MIG)



**Figure 2.4 : MIG Machine**

Metal Inert Gas (MIG) welding is an arc welding process in which a continuous solid wire electrode is fed through a welding gun and into the weld pool, joining the two base materials together. A shielding gas is also sent through the welding gun and protects the weld pool from contamination [13]. MIG welding is a versatile technique suitable for both thin sheet and thick section components. An arc is struck between the end of a wire electrode and the workpiece, melting both of them to form a weld pool. The wire serves as both heat source (via the arc at the wire tip) and filler metal for the welding joint. The wire is fed through a copper contact tube (contact tip) which conducts welding current into the wire. The weld pool is protected from the surrounding atmosphere by a shielding gas fed through a nozzle surrounding the wire [14]. Shielding gas selection depends on the material being welded and the application. The wire is fed from a reel by a motor drive, and the welder moves the welding torch along the joint line. A MIG welding machine is the only acceptable stainless steel welder. These machines are essential for making reliable, solid welds when working with stainless steel [14]. Therefore, this method of welding is the best to use because the project consists of materials made from stainless steel.

## 2.7 STAINLESS STEEL

Stainless steel is the name of a family of iron-based alloys known for their corrosion and heat resistance. One of the main characteristics of stainless steel is its minimum chromium content of 10.5%, which gives it its superior resistance to corrosion in comparison to other types of steels [15]. Once stainless steel is put into service, it does not need to be treated, coated or painted. The advantages of stainless steel are:-

- Corrosion resistant
- High tensile strength
- Very durable
- Temperature resistant
- Easy formability and fabrication
- Low-maintenance (long lasting)
- Attractive appearance
- Environmentally friendly (recyclable)

Stainless steel also have many types such as austenitic, ferritic, duplex and martensitic. The most common types of stainless steels are austenitic stainless steels. Compared to other types of stainless steels, austenitic stainless steels are extremely high in nickel content. Generally, they will also contain high amounts of chromium, nitrogen, and molybdenum. Ferritic stainless steels are stainless steels with low, but existing amounts of carbon. Generally, carbon consistencies in ferritic stainless steels don't exceed 0.10%. While other minerals can be added to these steels (molybdenum is a common additive), they primarily consist of chromium [16]. Duplex stainless steels are essentially combinations of ferritic and austenitic stainless steels. Stronger than both ferritic and austenitic stainless steels, they possess less nickel than austenitic steels. Because of this, they are also less expensive than austenitic steels. Martensitic stainless steels are structurally similar to ferritic stainless steels, with the only real differences being their percentages of carbon. While carbon percentages in ferritic stainless steel remain below 0.10%, carbon percentages in martensitic stainless steel hover around 1%. Stainless steel graded 304 is considered for the properties, availability and the cost that it offers.

### 2.7.1 STAINLESS STEEL FLAT BAR



**Figure 2.5 : Stainless Steel Flat Bar**

Stainless steel flat bars are widely used for industrial tools, mechanical parts, structure and escalator for construction. There are two methods of angle bars processing which are slit rolled edge and hot drawn. The flat bar is used as a platform to attached the spring to a hook in order for the spring to exert force by extending and compressing.

Specifications :

- Stainless Steel Grade 304
- 304 alloy is the most popular stainless steel alloys around, is commonly found in kitchen appliances, utensils, surfaces, chemical containers, food or liquid processing equipment, heat exchangers, automotive parts, construction materials, architectural trim, aerospace fixtures and etc.
- Dimension : 30 mm x 3 mm x 2 m
- Measurement allowed error is +/- 5%.
- Semi-smooth, dull grey finish.
- Workability: Good choice for some processing techniques.
- Great corrosion resistance.
- Good rust resistance.



## 2.7.2 STAINLESS STEEL ROD



**Figure 2.6 : Stainless steel Rod**

Stainless steel rod is one of the most vital components in the machining industry. With the key properties of strength and corrosion resistance, stainless steel round bars are employed in manufacturing industries concerned in the of fasteners, used for numerous strengthening applications as well as all manner of machinery [17]. The stainless steel rods are used as the material that will substitute the hammer in applying force to the nail. The kinetic force that is applied to the rod will be transferred to the nail.

Specifications :

- Stainless Steel Grade 304
- Good machinability
- High corrosion resistance
- Dimension:
  - 10 mm x 1 m
  - 25 mm x 500 mm
  - 20 mm x 16 mm x 500 mm

## **2.8 CHAPTER SUMMARY**

This chapter has reviewed the relevant theoretical literature used in the study to produce a safe tool for nailing. The chapter reviewed the necessary aspects such as materials, methods and mechanism to be applied in the project. The subject of the literature reviews are selected from the vision of the final outcome that has been specified initially. It is important to grasp the general idea of the project and knowing the final outcome. Therefore, these reviews are important and contributed in the development of the Mechanical Nailer.

## **CHAPTER 3**

### **METHODOLOGY**

#### **3.1 INTRODUCTION**

The project that is produced is a tool that will overcome the problem that involves safety in hammering nails on wood. The tool is developed using the method of research, survey and observation. Research is an important step in developing a product and is vital in ensuring that the outcome meets the aim that have been required initially. Research using the internet is the most common and easy way to gather information and data to apply to the project. Using websites that are related to hammers, nails, spring mechanisms and more, a proper amount of information is able to be obtained to use in creating a safe tool for nailing. The method of using online surveys is also used in making this project. This is a method that is widely used in research to gather data to improve and fabricate a product. A survey is a common way to get opinion and suggestion to be applied to the project or to aid in making better decisions in developing the project. By collecting the data that is necessary to be used in producing the tool through survey, the characteristics of the tool could be decided such as the design and mechanisms. Other than that, the method of observing is also implemented in completing this project. The method of observation is used in observing the way the hammer is used and analysing the mechanism. Observation in using the hammer is done by hammering a nail into the wood and identifying the safety hazard that it causes to the user. By observing the bow, the mechanism is applied to the project to be the major source of force that will be used to ensure that the nail goes into the wood properly. Therefore, by using methods in a research, a project can be successfully fabricated and executed.

### 3.2 FLOW CHART

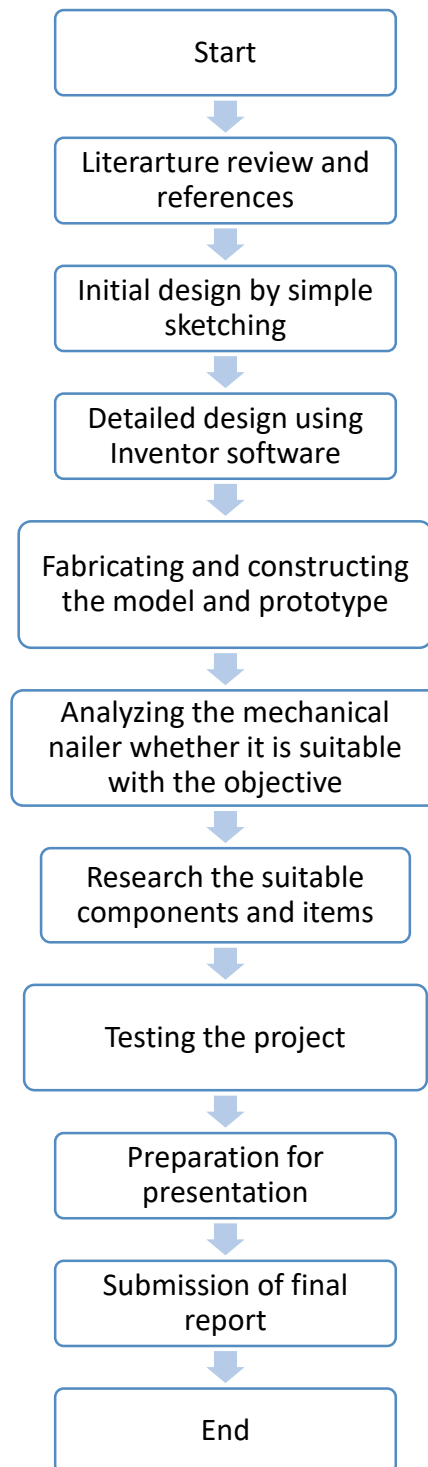

**Figure 3.0 : Flow Chart**

### **3.3 PROBLEM STATEMENT**

The first step is to initiate a literature review and survey. It is necessary to analyse relevant literature on other findings. This method will help identify the needs of the tool which would help in minimizing and avoid injuries and accidents that are caused by hammering and eliminating that safety hazard. To overcome the safety issue, the mechanical nailer is designed and invented in order to make one of the daily activities in life easier and safer.

### **3.4 FEATURES**

- a) Easy to use for a wide range of people.
- b) The simple design makes it portable and easy to store.
- c) The tool is durable and long lasting.
- d) Made out of stainless steel that is corrosion resistant.
- e) The rod has a thin layer of neoprene rubber sheet that provides cushioning to minimize the sound that is emitted when releasing the rod.
- f) A magnetic nail holder is provided to hold the nail in place during nailing.
- g) The tool can avoid and minimize accidents during nailing wood.

### **3.5 REQUIREMENT ANALYSIS**

In this step, research and observation is done to create questions to be included in the survey. The survey is opened for other students and public to fill in to help in making decisions such as the design and characteristics for the tool and obtaining information to solve the people's problem in nailing.

#### **PRODUCT SURVEY QUESTIONNAIRE (MECHANICAL NAILER)**

Gender

Male ( )

Female ( )

Age

15-19 ( )

20-24 ( )

25-29 ( )

30 and above ( )

1. Have you ever nailed a piece of wood before?

Yes ( )

No ( )

2. Did you ever injure yourself using a hammer when nailing before?

Yes ( )

No ( )

3. How often do you nail?

Always ( )

Occasionally ( )

Rarely ( )

Never ( )

4. Do you think using a spring mechanism in a nailing tool is a good idea ?

Yes ( )

No ( )

Maybe ( )

5. Do you think the common hammer is a design that is best to nail wood?

Yes ( )

No ( )

Maybe ( )

6. Do you prefer using a safer tool for nailing?

Yes ( )

No ( )

Maybe ( )

7. Do you get advantages if the product exists?

Yes ( )

No ( )

Maybe ( )

8. Do you think using a mechanical nailer is good for people who are inexperienced in nailing wood?

Yes ( )

No ( )

Maybe ( )

9. Between the hammer and mechanical nailer, which one do you prefer to use?

Hammer ( )

Mechanical Nailer ( )

### 3.6 DESIGN

The design of the project is an important step and is a vital part in ensuring that the project could be successfully developed and reach the cause that it is provided to meet. To do so, some designs are made using the Autodesk Inventor software in order to make a 3D design of the tool before proceeding to create a product model. There are three designs that are drawn and each of them has their own advantages and disadvantages. The designs are compared to each other to see which design is the best to be used in terms of the mechanics, complexity in making, use and cost.

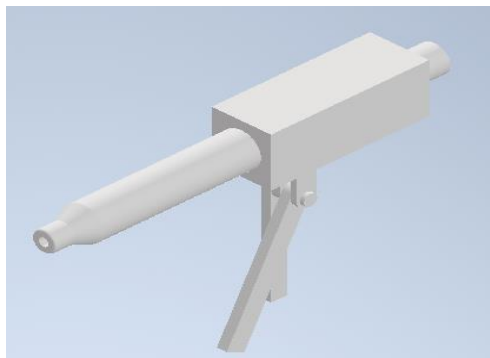

**Figure 3.1: Design 1**



The first design is inspired by a paper puncher which uses the force from squeezing to be applied to drive the nail into the wood. The nail is intended to be inserted from the side of the tool in a slot. This design is not efficient for nailing because it is big and may not be stable to use in nailing. The weight of the tool will make it much harder to nail a wood than using a regular hammer. It also have a higher level of complexity and skill in making compared to the two other designs. Therefore, this design does not meet the requirements in using as a safe tool for nailing which leads to the next design.



**Figure 3.2: Design 2**

The second design has a much sleeker and appealing design which is inspired by the mechanical pencil. This design is much smaller and lighter compared to the first design. However, this design cannot generate enough force to make sure that the nail is thoroughly inserted in the wood. This is because the force that comes from pressing is not enough and makes the act of nailing even harder to users because it will have to use a lot of physical energy. The light rod inside the body is also a problem because it could not provide enough force when pressed.

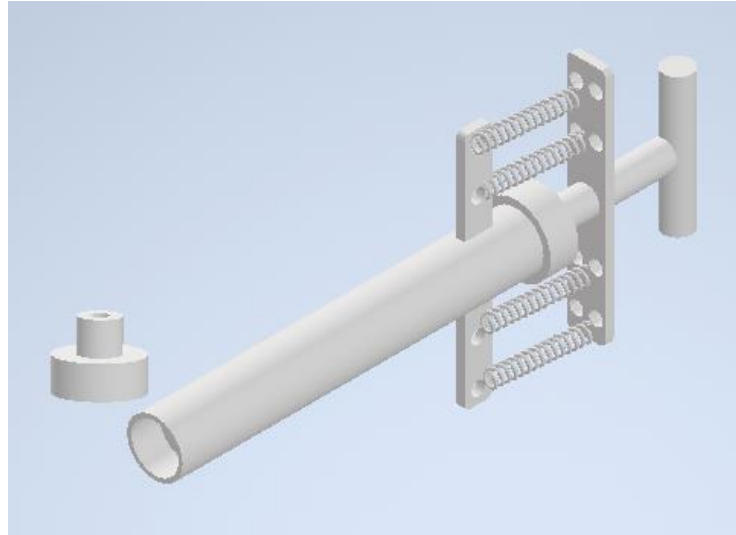

**Figure 3.3 : Design 3**

The last design uses the mechanism of a bow in generating force to be used in inserting the nail into the wood. The user only has to pull and release the rod with minimum effort. The force from the spring will be applied to the nail and ensure that the nail goes in to the wood without much physical energy. The magnetic nail holder is also a design that ensure the nail stays in place during the nailing process. Therefore, this design is picked to be the final design of the Mechanical Nailer.

## 3.7 WORKING PROCEDURE

### 3.7.1 MEASURING AND CUTTING

- 1) The materials that were used were measured and marked according to the measurement that has been provided from the drawing of the design. A ruler and Vernier caliper were used to measure the length and diameter of the stainless steel rod, flat bar and tube.
- 2) The cutting of stainless steel was done by using a metal cut-off saw.
- 3) The 1 meter, 10 mm diameter stainless steel was cut into two 80 mm and 300 mm.
- 4) Next, the 500 mm stainless steel tube was cut into 280 mm.
- 5) The 2 meter flat bar was cut into three pieces before being cut into a 100 mmx 30 mm flat bar.
- 6) The solid 500 mm stainless steel 25 mm diameter was cut into 20 mm and 10 mm.
- 7) A 10 mm 25mm diameter solid was cut to use for the magnetic holder.
- 8) A thin layer of neoprene rubber sheet was cut to provide cushioning.



**Figure 3.4 : Vernier Caliper**



**Figure 3.5 : Cut-Off Saw**

### 3.7.2 GRINDING

- 1) A grinder was used to grind the ends of the materials where it had been cut-off to obtain a smoother surface.
- 2) The flat metal bars' surfaces and edges were grinded using a grinder to produce a curved edge and obtain the shiny stainless steel surface.
- 3) Finishing was done on all the materials surface to have a level and appealing look.



**Figure 3.6 : Surface Grinder**



**Figure 3.7 : Hand Grinder**

### 3.7.3 DRILLING

- 1) A drilling machine was used to drill a hole into the 100 mm flat bar.
- 2) Next, the 20 mm solid was drilled to make a hole for the rod.
- 3) The 10 mm 25 mm solid was also drilled to make the magnetic holder.



**Figure 3.8 : Bench Drill**

### 3.7.4 WELDING

- 1) Metal Inert Gas also known as (MIG) welding was used to connect all the materials together to form the final product.
- 2) The power supply for the MIG machine was turned on and the voltage was checked initially to make sure that the machine works properly.
- 3) Then, a cable was connected to the material that was being welded.
- 4) The 300 mm 10 mm diameter rod were welded together to form the inner rod that will apply force to the nail.
- 5) Next, the 20 mm solid and 300 mm tube were welded together to form a the tool's body.
- 6) After that, both of the 80 mm 10 mm diameter rod were welded together in a T- shape.

- 7) The T- shaped rod was then welded with a flat bar that has been welded with hooks to hook the springs.
- 8) Then the rod welded in step four were welded together to form a final rod that was used to apply force to the nail.
- 9) The body of the tool was also welded with a flat bar with hooks.



**Figure 3.9 : MIG Machine**

### **3.7.5 ASSEMBLY**

- 1) The T- shaped rod was inserted into the body of the rod and the hooks were connected using four tension springs.
- 2) A super strong cylinder magnet was inserted into the 10 mm 25 mm diameter stainless steel to form a magnetic nail holder.

### 3.8 PRODUCT TESTING

Product testing is done to make sure that the mechanism in the Mechanical Nailer works properly and produce the desired results. A product testing is also executed to identify the weakness and limitations of the product during use.

- The method used to test this project is by nailing through a piece of wood using the Mechanical Nailer.
- Firstly, mark the place that is designated to nail.
- Then, place the magnetic holder on the mark.
- Insert the nail into the magnetic nail holder that is provided.
- Put the front of the Mechanical Nailer to the nail.
- Apply force to the spring by pulling the rod once and releasing it.
- Remove the magnetic holder from the nail.
- Proceed to pull and release the rod until the nail goes into the wood.
- Observe whether the nail has successfully been punctured into the wood or not.
- Record the result.

<b>Types of wood</b>	<b>Nail goes into the wood</b>	<b>Nail does not go into the wood</b>
Pine Wood		
Hard Wood		

**Table 3.0 : Product Testing**

### **3.9 CHAPTER SUMMARY**

This chapter describes the methodology used in the process of creating the product. The methods that were used consists of two parts which were research and observation. Research was done by gathering information from the internet and books. Observation was done by making survey of the product for the public. This chapter also covered the steps in creating the Mechanical Nailer and the process of designing the final product. Overall, the chapter explains the methods that were used to be able to execute the project.



## **CHAPTER 4**

### **RESULT AND DISCUSSION**

#### **4.1 INTRODUCTION**

The Mechanical Nailer is a tool that is aimed to complete the requirement of being a safe tool for nailing. This tool is focused on ensuring that the user does not injure other people or themselves during the process of nailing and creating a new and safer option in wood work.

This tool is user friendly and utilizes the spring mechanism to generate force to nail the wood. The fact that this project is targeted to create a tool for public, research has been done and a few methods were used to gain data and information to satisfy the user of this tool and acquire opinions and suggestions that could be useful to apply in the process of creating this tool.

There are a few aspects that are important to consider in creating this tool. Some of the aspects in creating this tool is design, portability, usefulness, and relevance. These aspects can be considered by analysing the data that has been gathered and discussing the outcome of the process.

## 4.2 DESIGN ANALYSIS

The responses for this project by using online surveys targeted to 50 students and the public were recorded and converted into a chart to analyse the result which could help in adding features to the tool that could satisfy the user and overcome their problem.

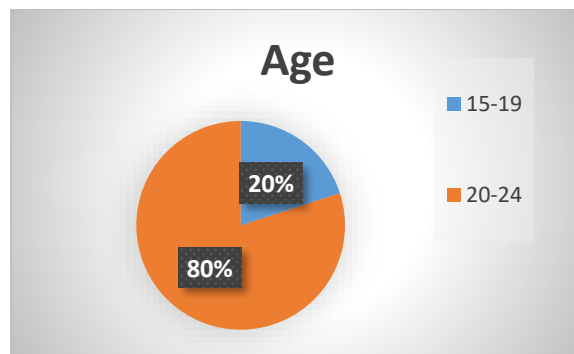

**Figure 4.0 : Age**

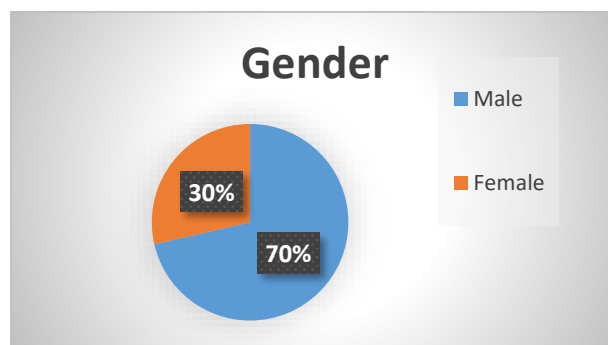

**Figure 4.1 : Gender**

From the pie charts above, it can be seen that out of 50 respondents, 10 ( 20%) of them range from the age 15 to 19 and 40 ( 80%) are aged 20 to 24. None of them are aged 25-29 and above 30. The pie chart above also shows the percentage of gender that had given responses to the surveys. The number show that 30% of the respondents which are 15 respondents are female and the other 70% which are 35 respondents consists of male.

1) Have you ever nailed a piece of wood before?

2) Did you ever injure yourself using a hammer when nailing before?

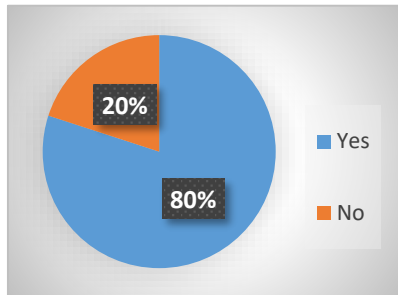

Figure 4.2 : Question 1

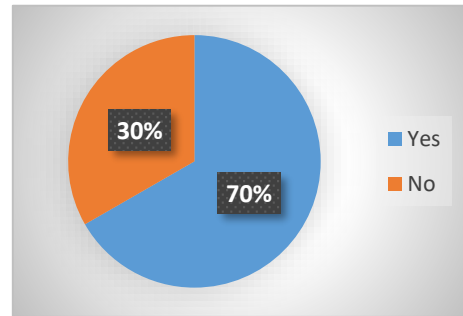

Figure 4.3 : Question 2

3) How often do you nail?

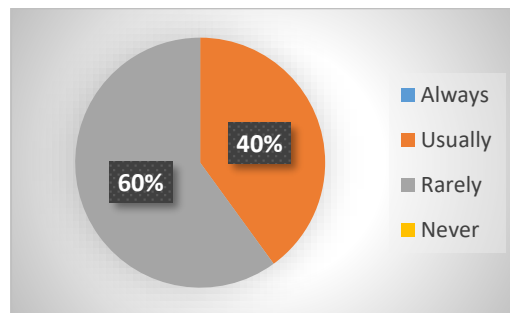
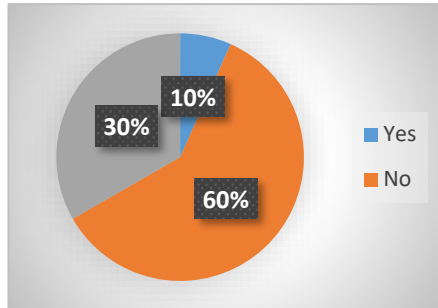

Figure 4.4 : Question 3

The charts show the results of some of the data obtained from the survey. The first chart shows that 10 (20%) respondents have no experience in nailing and 40 (80%) have experience in nailing. Next, the chart above also shows the number of people who have injured themselves while hammering. As much as 10 (20%) respondents have never injured themselves while hammering and 40 (80%) of them have. This shows that many people have experienced injury either minor or major from hammering. Other than that, 40% respondents usually nail and 60% of them rarely nail in their daily life. Thus, a number of 20 respondents nail wood in some circumstances and 30 rarely nail.

**4) Do you think using a spring mechanism in a nailing tool is a good idea?**



**Figure 4.5 : Question 4**

**5) Do you think the common hammer is a design that is best to nail wood?**

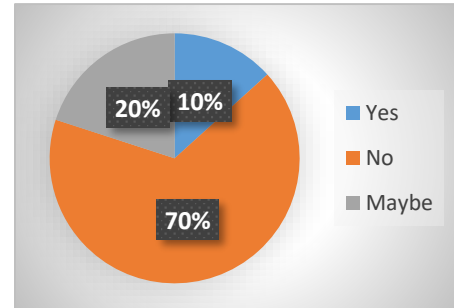

**Figure 4.6 : Question 5**

**6) Do you prefer using a safer tool for nailing?**

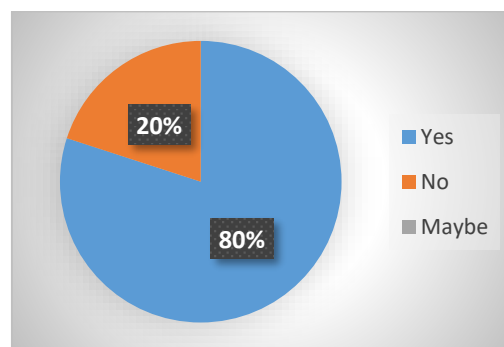

**Figure 4.7 : Question 6**

From the charts, it could be concluded that 15 (30%) respondents answered maybe to the idea of applying spring mechanism to the Mechanical Nailer , 5 (10%) answered no and the rest answered yes. Next, 30 (70%) respondents disagree that hammer is the best tool to nail wood , 10 (20%) respondents vote maybe and the remaining 5 (10%) agree that the hammer is the best tool for nailing wood. The result for picking a safer option for nailing shows that 40 (80%) of people prefer to have a safer option in nailing and the remaining 10 (20%) of people settled with using the hammer to nail.

7) Do you get advantages if the product exists?

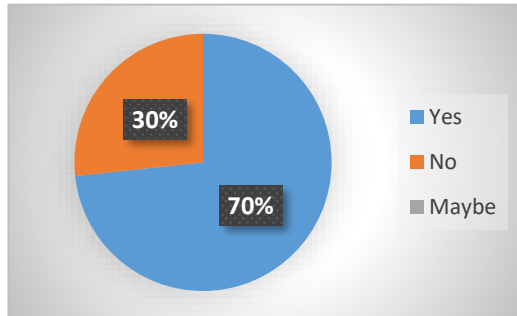

Figure 4.8 : Question 7

8) Do you think using a Mechanical Nailer is good for people who are inexperienced in nailing wood?

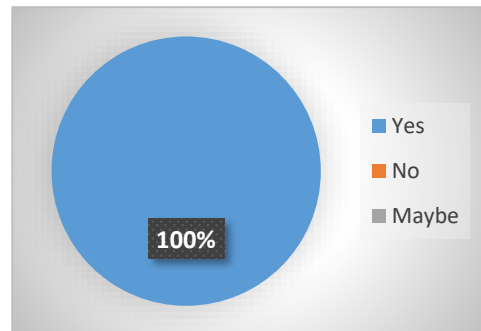

Figure 4.9 : Question 8

10) Between the hammer and Mechanical Nailer, which one do you prefer to use?

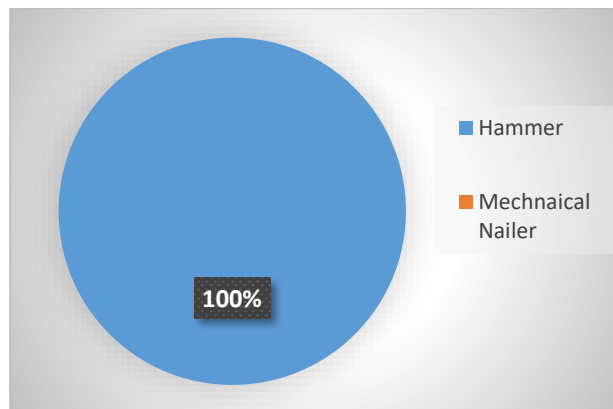

Figure 4.10 : Question 9

The pie chart on the left shows the percentage of people who would gain an advantage for the existence of the Mechanical Nailer. A number of 30 (70%) respondents think that they will gain an advantage for the existence of this tool and 20 (30%) answered that they will not gain any benefit from this tool. Other than that, all 50 respondents agree that using a Mechanical Nailer will help inexperienced people with nailing. All the respondents also would pick the mechanical nailer over the hammer for nailing based on the last pie chart.

### 4.3 RESULT

The result of the product testing was recorded into a table and analysed to determine the functionality of the tool. The advantages and disadvantages of the product could also be identified from the experiment.

<b>Types of wood</b>	<b>Nail goes into the wood</b>	<b>Nail does not go into the wood</b>
Pine Wood	/	
Hard Wood		/

**Table 4.0 : Result**

From the table above, the result shows that the nail goes into the pine wood and does not go into the hard wood fully using the Mechanical Nailer. This is because the Mechanical Nailer is intended to be used on softwood and not hardwood. This shows that the tool successfully meet the aim that was set initially by being able to nail into the pine wood fully. The magnetic holder was also able to make sure that the nail stays in place during nailing. Variables such as the force applied to the nail and the thickness of the woods that were used were constant to make sure that the result obtained was valid.

#### **4.4 ADVANTAGES**

There were a few advantages that can be identified from the product testing of the tool. It is important that the tool have an extra feature that could be a plus when comparing it with the traditional tool such as the hammer. The advantages of the Mechanical Nailer are :-

- Easy to use.
- Safe to use for nailing.
- Simple mechanics is applied.
- Does not acquire too much force to use.
- Uses a magnetic holder.
- Portable and easy for storage.
- Durable and long- lasting body.
- Prevents injuries especially finger injuries.

#### **4.5 DISADVANTAGES**

There are also some disadvantages in using this tool. The disadvantages of this tool could be overcome with more skill and thought. However, there were a few disadvantages that still came with the use of this tool. The disadvantages are :-

- The springs are outside of the body.
- The tool could only be used for wood.
- The tool could only be used for softwood.
- A flat surface is required to successfully nail the wood.
- The springs could damage easily if too much force is applied.
- Nails that cannot be attracted to magnet cannot be used.

## 4.6 PRODUCT DESCRIPTION



**Figure 4.11 : Mechanical Nailer**

The figure above shows the finished product of the Mechanical Nailer. The product uses stainless steel as the major material. This product uses the physical force by pulling and releasing the rod which is connected with the handle to generate force to nail the wood. The product consists of four springs which will help in supplying enough force to ensure that the nail goes fully into the wood. A thin layer of neoprene rubber sheet is used to provide cushioning and reduce noise during the releasing motion. The stainless steel rods, flat bars and tube were attached to each other by using MIG welding. This tool is an innovated version of the hammer inspired by the mechanics of the bow. The tool was successfully created with a lot of observation and research.



## 4.7 COSTING

The cost for this project was calculated and recorded to make sure that it does not go over the budget that was set initially. A cost estimation is an important step to be done to manage the project cost. The table below shows the cost for this project.

No.	Items	Price
I.	Stainless Steel Rod ( 10 mm diameter)	RM 13.30
II.	Stainless Steel Rod ( 25 mm diameter)	RM 48.30
III.	Stainless Steel Tube ( 20 mm diameter)	RM 15.00
IV.	Stainless Steel Flat Bar	RM 29.00
V.	Springs	RM 20.00
VI.	Nails	RM 5.00
VII.	Wood	RM 4.80
VIII.	Magnet	RM 1.40
<b>Total Price</b>		RM 136.80

**Table 4.1 : Costing**

## **4.8 CHAPTER SUMMARY**

This chapter presents overall results from the methods that had been applied to the project. It explains the data obtained from the survey and the information analysed from it. The results of the product testing was also discussed and the weakness and strength of the product were successfully identified. This chapter is vital in making sure that the process had been undergone correctly and have the desired outcome. It is also important in ensuring that all the relevant aspects shall be discussed and covered to make sure the project is properly executed.

## **CHAPTER 5**

### **CONCLUSION**

#### **5.1 INTRODUCTION**

The project to create a tool that is safe for nailing is coming to an end and was executed within the time frame that was given. All planning that have been set from the start had been run nicely although there were some problems and difficulties that occurred during the process. The issues in developing the project were discussed in a group and opinions were conveyed. The discussion is an important step in solving the problems that occurred to have a collective and mutual decision that will affect the outcome of the project.

#### **5.2 PROBLEMS AND CHALLENGES**

There were some problems that have been encountered during the making of the tool. Most of the problems involved welding the stainless steel together. This is because stainless steel is hard to weld and requires skill to do.

- The steel melts too quickly.
- The weld is not consistent.
- The stainless steel rods did not stick together.

### **5.3 SOLVING PROBLEMS**

Failure is a common thing in learning. Therefore, from the problems and challenges that occur, valuable things could be learned and applied to overcome those problems in the future. The problems were solved by :-

- Reducing the voltage on the MIG machine because the high temperature makes the stainless steel melt too easily and gives a hard time to weld the flat bar and hooks together.
- Increasing the speed of the road and in a constant motion to obtain a consistent weld.
- Clean the surface of the stainless steel from impurities that prevents the rods from being welded together.

### **5.4 OTHER PROBLEMS**

During the process of designing the project, many aspects of creating the tool have to be taken in account. These aspects are important to make sure that the tool can be created successfully. The aspects that have to be considered are :-

- Affordable materials
- Quality
- Relevance
- Complexity of the manufacturing
- Process involved
- Skill Required

All the stated aspects have to be considered first before proceeding with the creation of the tool to make sure that the tool can be made without going over the budget, have a good quality, relevant for users, do not have high complexity, and the skill required to make the tool is obtained.

## **5.5 CONCLUSION**

In conclusion, the project ended with a favourable outcome as the Mechanical Nailer was created. The process of designing the project was quite difficult and there were various obstacles that had been overcome in making sure that this project was a success. This project “Mechanical Nailer” succeeded with the observation and research that was done to create a safe tool for common daily people and carpenters to have a safer option in daily life and prevent less risk in nailing. We hope that this project could benefit people and one day be marketed widely throughout the country and be a formidable tool to compete with other more sophisticated nailing tool and devices.

## **5.6 CHAPTER SUMMARY**

The last chapter contains an overall summary of the project and explains the problems that occur and ways to solve them. The chapter concluded the project and informs that the project has reached the objective that was aimed at the start. This chapter also marks the ending of the project that has been done with the given time.

## REFERENCES

- [1] Hammer and Nail Injuries | Boston Work Accident Lawyer Pulgini & Norton. (2019). Retrieved September 25, 2020, from Pulginorton.com website: <https://www.pulginorton.com/hammer-and-nail-injuries.html>
- [2] Accident Report Detail | Occupational Safety and Health Administration. (2020). Retrieved September 25, 2020, from Osha.gov website: [https://www.osha.gov/pls/imis/accidentsearch.accident\\_detail?id=201500345](https://www.osha.gov/pls/imis/accidentsearch.accident_detail?id=201500345)
- [3] Dropped object: Failure of lump hammer – IMCA. (2017, February 15). Retrieved September 25, 2020, from IMCA website: <https://www.imca-int.com/alert/881/dropped-object-failure-of-lump-hammer/>
- [4] Lee, A. (2016, May 25). MC Hammer doesn't like hammers, "Using hammers is a scary proposition, man." Retrieved October 23, 2020, from Metro website: <https://metro.co.uk/2016/05/25/mc-hammer-doesnt-like-hammers-and-destroys-everything-we-believed-about-the-90s-5903693/>
- [5] Parkkinen, V.-P., Wallmann, C., Wilde, M., Clarke, B., Illari, P., Kelly, M. P., ... Williamson, J. (2018). An Introduction to Mechanisms. Evaluating Evidence of Mechanisms in Medicine, 11–21. [https://doi.org/10.1007/978-3-319-94610-8\\_2](https://doi.org/10.1007/978-3-319-94610-8_2)
- [6] <https://www.howstuffworks.com>. (2007, March 15). Hammer. Retrieved October 25, 2020, from HowStuffWorks website: <https://home.howstuffworks.com/hammer.htm>
- [7] Different types of hammers - what there are, and what each type is designed for. (2020). Retrieved October 25, 2020, from Diydata.com website: <https://www.diydata.com/tool/hammer/hammers.php>
- [8] Compound Bows Parts and Functions - The Best Compound Bows. (2017, March 12). Retrieved October 25, 2020, from The Best Compound Bows website: <http://thebestcompoundbows.com/compound-bows-parts-functions/>
- [9] How'd They Do That Tuesday: Bow and Arrows. (2009, February 24). Retrieved October 25, 2020, from Physicscentral.com website:

<http://physicsbuzz.physicscentral.com/2009/02/howd-they-do-that-tuesday-bow-and.html>

[10] Creative Mechanisms. (2016). Springs. Retrieved October 25, 2020, from Creativemechanisms.com website:  
[https://www.creativemechanisms.com/springs#:~:text=Spring%20Mechanisms&text=Springs%20are%](https://www.creativemechanisms.com/springs#:~:text=Spring%20Mechanisms&text=Springs%20are%20)

[11] Types of Springs - A Thomas Buying Guide. (2020). Retrieved October 25, 2020, from Thomasnet.com website: <https://www.thomasnet.com/articles/machinery-tools-supplies/types-of-springs/>

[12] Neoprene Sheet / Chloroprene rubber (CR). (2020). Retrieved October 25, 2020, from Rugaval.com website: <https://www.rugaval.com/ProductDetail/neoprene-sheet-chloroprene-rubber-cr-/4db70305-10aa->

[13] MIG welding process. (2020). Retrieved October 25, 2020, from Advantagefabricatedmetals.com website:  
<http://www.advantagefabricatedmetals.com/mig-welding.html>

[14] How to Weld Stainless Steel. (2020). Retrieved October 25, 2020, from The Home Depot website: <https://www.homedepot.com/c/ah/how-to-weld-stainless-steel/9ba683603be9fa5395fab9014a903126>

[15] Characteristics of Stainless Steel: Grades, Properties, and Applications. (2019, June 17). Retrieved October 25, 2020, from Eagle Stainless website:  
<https://eagletube.com/about-us/news/stainless-steel-characteristics/>

[16] Great Plains Stainless. (2018, November 24). 4 Types of Stainless Steel | Great Plains Stainless. Retrieved October 25, 2020, from Great Plains Stainless website:  
<https://www.gpss.com/types-stainless-steel/>

[17] Stainless Steel Rod: Beauty, Strength, Resistance | Metal SuppliesTM. (2018, January 26). Retrieved October 25, 2020, from Metal Supplies website:  
<https://www.metalsupplies.com/stainless-steel-rod/>

