



LAPORAN CADANGAN PROJEK 1

COOKED RICE DISPENSER

| GROUP MEMBER | NO. MATRIC |
|---------------------------|-------------------|
| LIM TIAN YUAN | 08DKM20F1079 |
| VADIVALAGAN A/L SAGADEVAN | 08DKM20F1058 |
| PRADHIV A/L SELVAKUMARAN | 08DKM20F1059 |

SUPERVISOR:

ENCIK ZULKARNAIN BIN HAMID

JABATAN KEJURUTERAAN MEKANIKAL

SESI 2 2021/2022

POLITEKNIK SULTAN SALAHUDDIN ABDUL AZIZ SHAH

COOKED RICE DISPENSER

| NAME | MATRIX NO |
|---------------------------|------------------|
| LIM TIAN YUAN | 08DKM20F1079 |
| VADIVALAGAN A/L SAGADEVAN | 08DKM20F1066 |
| PRADHIV A/L SELVAKUMARAN | 08DKM20F1059 |

Laporan ini dikemukakan kepada Jabatan Kejuruteraan Mekanik sebagai memenuhi sebahagian syarat penganugerahan Diploma Kejuruteraan Mekanikal

JABATAN KEJURUTERAAN MEKANIKAL

SESI 2 2021/2022

DECLARATION OF ORIGINALITY AND OWNERSHIP

TITLE : COOKED RICE DISPENSER

SESSION : JUN 2020

1. We, **1) LIM TIAN YUAN (08DKM20F1079)**
2) PRADHIV A/L SELVAKUMARAN (08DKM20F1059)
3) VADIVALAGAN A/L SAGADEVAM (08DKM20F1058)

are final year students of **Diploma in Mechanical Engineering, Department of Mechanical Engineering, Politeknik Sultan Salahuddin Abdul Aziz Shah**, which is located at **Persiaran Usahawan, 40150 Shah Alam, Selangor.**

2. We recognize that the ‘project on’ and intellectual property contained in it is the work / design our original without taking or imitate any intellectual property rights of other parties.
3. We agreed to relinquish ownership of intellectual property ‘project’ to ‘Polytechnic’ to meet the needs of the award of **Diploma in Mechanical Engineering** to us.

Made and truthfully recognized by the;

- a) (LIM TIAN YUAN)
(NO IC :- 020506-10-1545) LIM TIAN YUAN
- b) (PRADHIV A/L SELVKUMRAN)
(021109-07-0591) PRADHIV A/L SELVAKUMARAN
- c) (VADIVALAGAN A/L SAGADEVAN)
(020712-05-0195) VADIVALAGAN A/L SAGADEVAN

At....., on.....)

Infront of me, ZULKARANAIN BIN HAMID)
as a supervisor on the date :.....) ZULKARANAIN BIN HAMID

ACKNOWLEDGEMENT

First and foremost, we want to raise our hands to give our gratitude to god for giving us the chance to complete this research and project.

In this current era of competition, there is a common issue where the ones who are already at the top of the world, will continue to succeed and leave the other behind. A project is like a bridge that connects theory and practical work. We took effort in this project, however, it would not have been possible without the kind support and assistance of various individuals and organisations. I would like to extend my sincere gratitude to all of them.

We are thankful to our supervisor, En Zulkarnain bin Hamid who's guidance and encouragement from the beginning to the very end of our study, giving suggestions and ideas to complete our research in relation to our project, helped us to coordinate our project especially writing the proposal and during the fabrication process of our process. Besides, our supervisor never gets tired to spend his precious time to assist us in managing the research and also did not disappoint us when we needed his help with advice and guidance.

We are pleased to extend our thanks to our friends and families who gave strong support that assisted us in completing this report and project, and also gave their ideas in some parts. Our success would not be possible without all of their support upon completing this report. Thank you for all the constructive advice and criticism that helped throughout the research and study of our project, the Cooked Rice Dispenser.

Contents

| | |
|--|----|
| ABSTRACT | 5 |
| 1.0 INTRODUCTION..... | 6 |
| 1.1 RESEARCH BACKGROUND..... | 7 |
| 1.2 PROBLEM STATEMENT | 8 |
| 1.3 RESEARCH OBJECTIVE..... | 9 |
| 1.4 RESEARCH QUESTION..... | 9 |
| 1.5 PROJECT SCOPE | 10 |
| 1.6 THE IMPORTANCE OF THE PROJECT | 10 |
| 1.7 CHAPTER SUMMARY | 10 |
| 2.0 LITERATURE REVIEW..... | 11 |
| 2.1 INTRODUCTION..... | 11 |
| 2.2 MARKETING RESEARCH..... | 15 |
| 2.3 RESEARCH OF MATERIAL AND EQUIPMENT | 18 |
| 2.4 FIELD RESEARCH..... | 21 |
| 2.5 CHAPTER SUMMARY | 23 |
| 3.0 METHODOLOGY..... | 24 |
| 3.1 INTRODUCTION..... | 24 |
| 3.2 FLOW CHART..... | 25 |
| 3.3 BUDGET CALCULATIONS..... | 33 |
| 3.4 PROGRAMMING APPLICATION | 34 |
| 3.5 CHAPTER SUMMARY | 35 |
| 4.0 RESULTS | 36 |
| 4.1 INTRODUCTION..... | 36 |
| 4.2 ADVANTAGES AND DISADVANTAGES | 36 |
| 4.3 ANALYSIS | 37 |
| 4.4 CHAPTER SUMMARY | 41 |
| 5.0 DISCUSSION | 42 |
| 5.1 INTRODUCTION..... | 42 |
| 5.2 DISCUSSION | 43 |
| 5.3 PROBLEM..... | 44 |
| 5.4 RECOMMENDATION | 45 |
| 5.5 CONCLUSION | 46 |
| REFERENCES..... | 47 |
| APPENDIX | 48 |

ABSTRACT

This project is based on the conventional method of serving **cooked rice** to the plate in a restaurant or buffet setting. The goal of this project is to create an automatic **Cooked Rice Dispenser** to replace any the usage of a normal scooper or spoon and a manual dispenser. Additionally, the application of multiple study areas that have been studied, an example can be shown in this product's use of internet of things (IoT) that uses an Arduino Uno to provide intelligent and efficient output to the various mechanical components. The dispenser is designed to address any issues that may be brought up, such as the delivery method, hygiene and different textures or consistencies of cooked rice. As for the essential materials, a high torque AC motor, gear servos and Arduino to control them are needed in order assist in the process of dispensing the cooked rice onto a plate.

CHAPTER 1

INTRODUCTION

1.0 INTRODUCTION

Serving rice is a process often overlooked by people as something that doesn't need to be changed or innovated. The conventional way of serving rice with a rice spoon or scoop is accepted to be the norm thus no one thinks of a better way to make the entire process better. In a commercial setting like in a restaurant or buffet, using the normal method of manually scooping the rice can be tedious and could take long time that sometimes causes a long queue to be formed thus an effective way to overcome this issue is the implementation of an automated way to dispense cooked rice.

You may think there are various rice dispensers in the market now but the important thing you wouldn't notice is that they all mostly dispense uncooked rice or grains of rice to be cooked. They mostly are used to store, measure and dispense the rice grains that are then used to cook. Our product, the COOKED RICE DISPENSER dispenses rice that has already been cooked directly onto a plate. Our COOKED RICE DISPENSER is a new product that isn't only suitable for the commercial setting but also for personal usage at home. The consistency of serving the rice makes it suitable for usage in restaurants and buffets that want to save cost, ensure hygiene, reduce wastage, and keep cleanliness around the serving area. The usage of a microcontroller to automatically open the doors to dispense the rice using a proximity sensor also showcases the usage of Internet of Things in modern technology.

1.1 RESEARCH BACKGROUND

Rice is consumed in nearly every household, restaurant, buffet, canteen and other places that serve food in our country. It is an essential part of a Malaysian's diet so serving rice should not be a process that is overlooked.

The idea for the COOKED RICE DISPENSER came into place when it was observed that in the food court at Politeknik Sultan Salahuddin Abdul Aziz Shah (PSA) had a rice container with a scooper inside to scoop the rice onto the plate. The entire process was seen to be unhygienic, unclean, slow, causes a lot of wastage and causes the food court operators to run at a loss since people take a lot of rice thus lacking consistency per plate.

The implementation of a COOKED RICE DISPENSER would be perfect for that kind of environment since it solves all the issues without creating new problems. The automated process using an Arduino Uno microcontroller also makes it easier to use. The COOKED RICE DISPENSER also runs purely on electricity so no emissions are released in the product that could contaminate the rice and make it unsafe to consume or eat.

1.2 PROBLEM STATEMENT

Serving rice in the commercial setting manually is generally seen as normal but there are multiple issues with that process that could be overcome by the usage of the COOKED RICE DISPENSER.

Serving rice manually is actually unhygienic. The sharing of the scooper between many people is seen as unhygienic since we don't know if the other person using it has washed their hands or do they have clean hands. So it is not suitable to use the conventional rice scoop to scoop the rice onto the plates.

The conventional process also causes a lot of wastage. When observing a commercial setting, it can be seen that when scooping the rice onto the plate, people tend to drop some rice onto the ground. If every person does it without knowing, the total amount of rice that goes to waste is a lot. Thus this method causes the rice to go to waste.

Besides causing wastage, when the rice drops onto the floor while scooping it onto the plate, it makes the whole area dirty. People will step on the rice and walk around the area with rice stuck on the soles of their shoes. The entire serving area will be sticky and dirty because of all the rice dropped.

The manual method of serving rice is also seen as inefficient and slow. Scooping the rice onto the plate could take long and cause a long queue to be formed in a commercial place like a restaurant or buffet. A more efficient method would make the entire process faster.

In a commercial setting, scooping rice manually can cause losses to the people who run the businesses. People will take large portions of rice if they scoop it themselves so if the rice is dispensed consistently with the same amount, the amount of plates of rice that can be served is easily determined.

1.3 RESEARCH OBJECTIVE

The aim of this project is to build a COOKED RICE DISPENSER that dispenses cooked rice onto a plate automatically.

The objectives to this research are:

- i. For the design of our dispenser, we are looking to achieve an ergonomic and suitable design that not only looks aesthetically pleasing, but also ensures the core functionality for example, it can still hold large sum of rice even in its relatively portable form factor.
- ii. For the fabrication of our dispenser, we want to use strong and lightweight material that is not only durable but also light enough to carry it around. The materials should also be water and stain resistant that makes it easy to clean to prevent from dirt getting into the rice.
- iii. When testing our dispenser, we hope that our product can hold the rice and dispense the rice quickly and effectively. We also hope that the proximity sensor will detect and send signals that will begin the process of dispensing the rice.

1.4 RESEARCH QUESTION

This study will answer the following research questions:

- i. Is there an automated way to dispense the cooked rice more effectively and efficiently than the conventional method?
- ii. What would be the requirements to create a automatic COOKED RICE DISPENSER?
- iii. How microcontrollers and sensors can be used to automate the process of dispensing the cooked rice?

1.5 PROJECT SCOPE

- I. The Cooked Rice Dispenser is an effective improvement in the conventional method of using a normal rice scooper or even a manual dispenser. Therefore, the introduction of this product into the market will not only benefit for domestic usage but also the commercial market.
- II. The Cooked Rice Dispenser is targeted more towards commercial use in restaurants or events that ease and controls the amount of rice being served to plates.
- III. Even if the dispenser can hold large amount of rice, the rice still needs to be manually filled up once it finishes.

1.6 THE IMPORTANCE OF THE PROJECT

The Cooked Rice Dispenser will be really important not only for personal usage at homes but mainly for commercial settings like restaurants and buffets. The development of this product will make not only the workers or business owners' work easier but also the public and consumer's work easier. Buffet owners for example don't have to hire an extra worker to serve rice manually that would waste time. Furthermore, the dispenser operates automatically so the public don't have to put too much effort in self-service buffets to put cooked rice on their plates.

1.7 CHAPTER SUMMARY

The ideas and inspirations discovered in this chapter can be gleaned from the research conducted. Every issue must have a solution. The goal and significance of this product may be concluded as follows: serving rice manually can be filled with issues that should not be overlooked, so an automated method of dispensing cooked rice solves all the issues. Implementing the production of this product is a vital first step in resolving the issues that have arisen.

CHAPTER 2

LITERATURE REVIEW

2.0 LITERATURE REVIEW

2.1 INTRODUCTION

This chapter will describe the research conducted based on the theories that are true and have been applied in the field. For example, through journals, articles, and so on. In addition, some theories and a few methodologies will be described in this chapter to answer the problems faced today that can help society in the future.

After wheat, rice is the crop with the second-largest planting area. A total of 155 million hectares (ha) of rice were produced globally in 1999, yielding 596.5 million tonnes. More than a hundred nations in Asia, Latin America, and Africa contain the main rice-growing regions. But only Thailand, the United States, Vietnam, Pakistan, and India are significant rice exporters. The majority of rice produced is for human consumption—about 85%. In the world, rice contributes 16% of the protein and 23% of the energy consumed per person (IRRI, 1997). Rice is often consumed twice or three times each day in Asia. Over 90% of the rice consumed worldwide is produced on 250 million rice farms, with each farm having an average rice field area of less than 1 ha. For instance, the average yearly consumption of rice in Europe and America is 3 kg and 7 kg, respectively, compared to Myanmar's 195 kg per capita. With a combined population of 2.5 billion, the three most populous countries are rice-producing countries: China, India, and Indonesia (about half of the current world population).

For the cooked rice dispenser, Rice Dispenser is an automated machine that dispenses rice without the use of any manpower. The rice that is being dispensed will be evenly spread and not pressed when its being served. Rice Dispenser is the latest sushi machine in the world. Rice Dispenser is a must have item for any catering company or food establishment. Cooked rice dispenser is automated rice dispenser produced specifically to ensure your rice will be dispensed in many different ways such as Rice bowls, food trays, lunch boxes etc., and many more. By pouring the boiled rice into the hopper of the rice dispenser, the mixer of the rice dispenser will mix the rice loosely and dispense it at the demand weight into the bowl, plate or take-away box.

2.1.1 COMPARISON OF THE OLD METHOD AND THE INNOVATED METHOD

CONVENTIONAL RICE SCOOPING METHOD VS COOKED RICE DISPENSER.

| Conventional Rice Scooping Method | Cooked Rice Dispenser |
|--|--|
| <p>➤ Scooping rice onto the plate with a spoon manually is slow and inefficient: The conventional method of scooping rice onto the plate takes time and causes a delay. Although it is still the preferred choice for the consumer since they can control the amount of rice they want.</p> | <p>➤ Automatically dispenses rice in 5 seconds: The cooked rice dispenser, when the proximity sensor senses a plate, it will begin to dispense rice by turning the spiral and opening the bottom doors for exactly 5 second to dispense the rice. This ensures efficiency and consistent time taken for each plate to be served with cooked rice.</p> |
| <p>➤ Wastage of rice: This method may bring in a problem where large quantities of rice will cumulatively be wasted. This is due to the fact that when the consumer or a server puts rice on the plate, some of the rice may fall onto the floor causing a wastage of the cooked rice.</p> | <p>➤ Prevents wastage of the cooked rice: The bottom doors that dispense the rice will direct the rice straight onto the plate. This directly reduces the chances of the rice dropping down on the floor since it goes straight onto the plate automatically. All the user has to do it avoid from removing the plate too fast.</p> |

| | |
|---|--|
| <p>➤ There will be an issue of hygiene: As we all know, hygiene is an important factor that should be given attention. The sharing of one rice scooper by many people, then putting it back in the rice container on the rice is obviously not advisable since it can contaminate the cooked rice due to some irresponsible people that might not have washed or cleaned their hand.</p> | <p>➤ Hygiene can be always ensured: The use of the infrared proximity sensor to begin the process of dispensing the rice avoids the usage of a button. Therefore, all contact can be avoided. This ensures that hygiene is kept through the usage of the Cooked Rice Dispenser.</p> |
|---|--|

Table 2.1.1

2.1.2 COMPARISON OF NORMAL SCOOPING RICE AND COOKED RICE DISPENSER.

| | RICE SCOOPER | Cooked Rice Dispenser |
|--------------------------------|--|--|
| Accuracy | <p>NO ACCURATE AMOUNT OF RICE. (BASED ON YOUR OWN AMOUNT)</p> <p>This means you need to scoop your cooked rice manually by using rice scooper.</p> <p>Sometimes curtain people don't know whether the amount of rice is enough for them.</p> <p>Because of that it will waste those rice by throwing them away.</p> | <p>VARIES DEPENDING ON AMOUNT OF RICE AND ENVIRONMENTAL CONDITIONS.</p> <p>5 seconds/dish (250 g)</p> <p>This means you don't need to scoop the rice using rice scooper.</p> <p>You just need to put your plate at the specific place and the rice will dispense itself for 250g.</p> <p>This will help those rice will not get wasted by getting to big amount of rice.</p> |
| ENERGY | <p>USE MORE ENERGY</p> <p>Using scoop rice will waste more energy.</p> | <p>USE LESS ENERGY</p> <p>Save more energy while getting rice and save time to avoid from getting a long queue.</p> |
| HYGIENE AND CLEANLINESS | <p>Sharing the same rice scooper with others in the restaurant.</p> | <p>Don't need to get in touch with the rice and will keep good distance between each other.</p> |

Table 2.1.2

2.2 MARKETING RESEARCH

After I did some research on the products available in the market, I found that there are a few forms and types of rice dispensers. Of the few automatic plant waterers, I have found out that most of it use a different type of method to deliver the rice.

Personally, the rice dispensers on the market are far less effective. The most of them are usually only able to dispense out rice grains. Although this could be manufactured cheaply, it does not serve the main purpose as compared to our project that dispenses out cooked rice. For the few that can dispense cooked rice, the main issue is that they are built to be too complicated. This directly affects the cost to produce them, thus increasing the selling price that makes it less marketable in our country.



Figure 2.2.1



Figure 2.2.2



Figure 2.2.3



Figure 2.2.4



Figure 2.2.5

To overcome all the issues that arose, we will create a product that keeps the cooked rice dispensing process simple, as fast as possible, and efficient. It can also be cut down to a cheaper cost to produce, thus reducing the selling price that will attract more consumers to use this product. This can be done by using cheaper, but good quality materials, making the process simple and straight forward. This can cause the

The product uses an Arduino UNO, servo motor, and infrared sensor module to detect the motion and the amount fo rice dispense as well as to limit the amount of rice that comes out.

2.3 RESEARCH OF MATERIAL AND EQUIPMENT

1. Arduino

Arduino is an open-source hardware and software company, project, and user community that designs and manufactures single-board microcontrollers and microcontroller kits for building digital devices. Its hardware products are licensed under a CC BY-SA license, while the software is licensed under the GNU Lesser General Public License (LGPL) or the GNU General Public License (GPL),^[1] permitting the manufacture of Arduino boards and software distribution by anyone. Arduino boards are available commercially from the official website or through authorized distributors.

Arduino board designs use a variety of microprocessors and controllers. The boards are equipped with sets of digital and analogue input/output (I/O) pins that may be interfaced to various expansion boards ('shields') or breadboards (for prototyping) and other circuits. The boards feature serial communications interfaces, including Universal Serial Bus (USB) on some models, which are also used for loading programs. The microcontrollers can be programmed using the `C` and C++ programming languages, using a standard API which is also known as the **Arduino language**, inspired by the Processing language and used with a modified version of the Processing IDE. In addition to using traditional compiler toolchains, the Arduino project provides an integrated development environment (IDE) and a command-line tool developed in Go.

The Arduino project began in 2005 as a tool for students at the Interaction Design Institute Ivrea, Italy, aiming to provide a low-cost and easy way for novices and professionals to create devices that interact with their environment using sensors and actuators. Common examples of such devices intended for beginner hobbyists include simple robots, thermostats, and motion detectors.

The name *Arduino* comes from a bar in Ivrea, Italy, where some of the founders of the project used to meet. The bar was named after Arduino of Ivrea, who was the margrave of the March of Ivrea and King of Italy from 1002 to 1014.

2. Infrared sensor module

The IR Sensor Module or infrared (IR) sensor is a basic and most popular sensor in electronics. It is used in wireless technology like remote controlling functions and detection of surrounding objects/ obstacles. IR sensors mainly consist of an Infrared(IR) LED and a Photodiode, this pair is generally called IR pair. An IR LED is a special purpose LED, it is can emitting infrared rays ranging from 700 nm to 1 mm wavelength. These types of rays are invisible to our eyes. In contrast, a photodiode or IR Receiver LED detects the infrared rays.

The emitter is simply an IR LED (Light Emitting Diode), and the detector is simply an IR photodiode. Photodiode is sensitive to IR light of the same wavelength which is emitted by the IR LED. When IR light falls on the photodiode, the resistances and the output voltages will change in proportion to the magnitude of the IR light received.

There are five basic elements used in a typical infrared detection system: an infrared source, a transmission medium, optical component, infrared detectors or receivers and signal processing. Infrared lasers and Infrared LEDs of specific wavelength used as infrared sources.

The three main types of media used for infrared transmission are vacuum, atmosphere and optical fibres. Optical components are used to focus the infrared radiation or to limit the spectral response.

3. SERVO MOTOR

Servo motors are used to control the position of objects, rotate objects, move legs, arms or hands of robots, move sensors etc. with high precision. Servo motors are small in size, and because they have built-in circuitry to control their movement, they can be connected directly to an Arduino.

The servo motor has some control circuits and a potentiometer (a variable resistor, aka pot) connected to the output shaft. In the picture above, the pot can be seen on the right side of the circuit board. This pot allows the control circuitry to monitor the current angle of the servo motor.

If the shaft is at the correct angle, then the motor shuts off. If the circuit finds that the angle is not correct, it will turn the motor until it is at a desired angle. The output shaft of the servo is capable of traveling somewhere around 180 degrees. Usually, it is somewhere in the 210-degree range, however, it varies depending on the manufacturer. A normal servo is used to control an angular motion of 0 to 180 degrees. It is mechanically not capable of turning any farther due to a mechanical stop built on to the main output gear.

The power applied to the motor is proportional to the distance it needs to travel. So, if the shaft needs to turn a large distance, the motor will run at full speed. If it needs to turn only a small amount, the motor will run at a slower speed. This is called proportional control.

2.4 FIELD RESEARCH

Go to restaurant to do some research and find information.



Picture 2.4.1



Picture 2.4.2



Picture 2.4.3

After doing research and questionnaires at Hao Restaurant, we have gained some information about rice scooping and the hygiene. We asked about the needs, effects and also some differences of the way of scooping rice or rice dispensing. Cooked rice should be in a soft and fluffy condition and it is fully cooked only can ready to be served. Including brown rice and jasmine rice.

2.5 CHAPTER SUMMARY

As a conclusion to this chapter, the literature review is critical in highlighting all the research on materials and techniques to expand understanding about this project. After much discussion and investigation, the most significant item for our project was the Arduino. This is due to the fact that Arduino serves as the primary master, controlling the project's movement and activities. Finally, because of its low and fair price, this product is highly suited and economical.

CHAPTER 3

METHODOLOGY

3.0 METHODOLOGY

3.1 INTRODUCTION

Methodology is the study of research methods or, more formally, "a contextual framework for research, a coherent and logical scheme based on views, beliefs, and values, that guides the choices researchers [or other users] make

It comprises the theoretical analysis of the body of methods and principles associated with a branch of knowledge such that the methodologies employed from differing disciplines vary depending on their historical development. This creates a continuum of methodologies that stretch across competing understandings of how knowledge and reality are best understood. This situates methodologies within overarching philosophies and approaches.

Methodology may be visualized as a spectrum from a predominantly quantitative approach towards a predominantly qualitative approach. Although a methodology may conventionally sit specifically within one of these approaches, researchers may blend approaches in answering their research objectives and so have methodologies that are multimethod and/or interdisciplinary.

In general, a methodology proposes to provide solutions, therefore, the same as a method. Instead, a methodology offers a theoretical perspective for understanding which method, set of methods, or best practices can be applied to the research question at hand.

3.2 FLOW CHART

In this chapter, there will be a lot of information about the process and journey throughout the making of our final project. There will be a flow chart showing the process of us making the whole project. Figure 3 which is our flow chart will explain the processes we took.

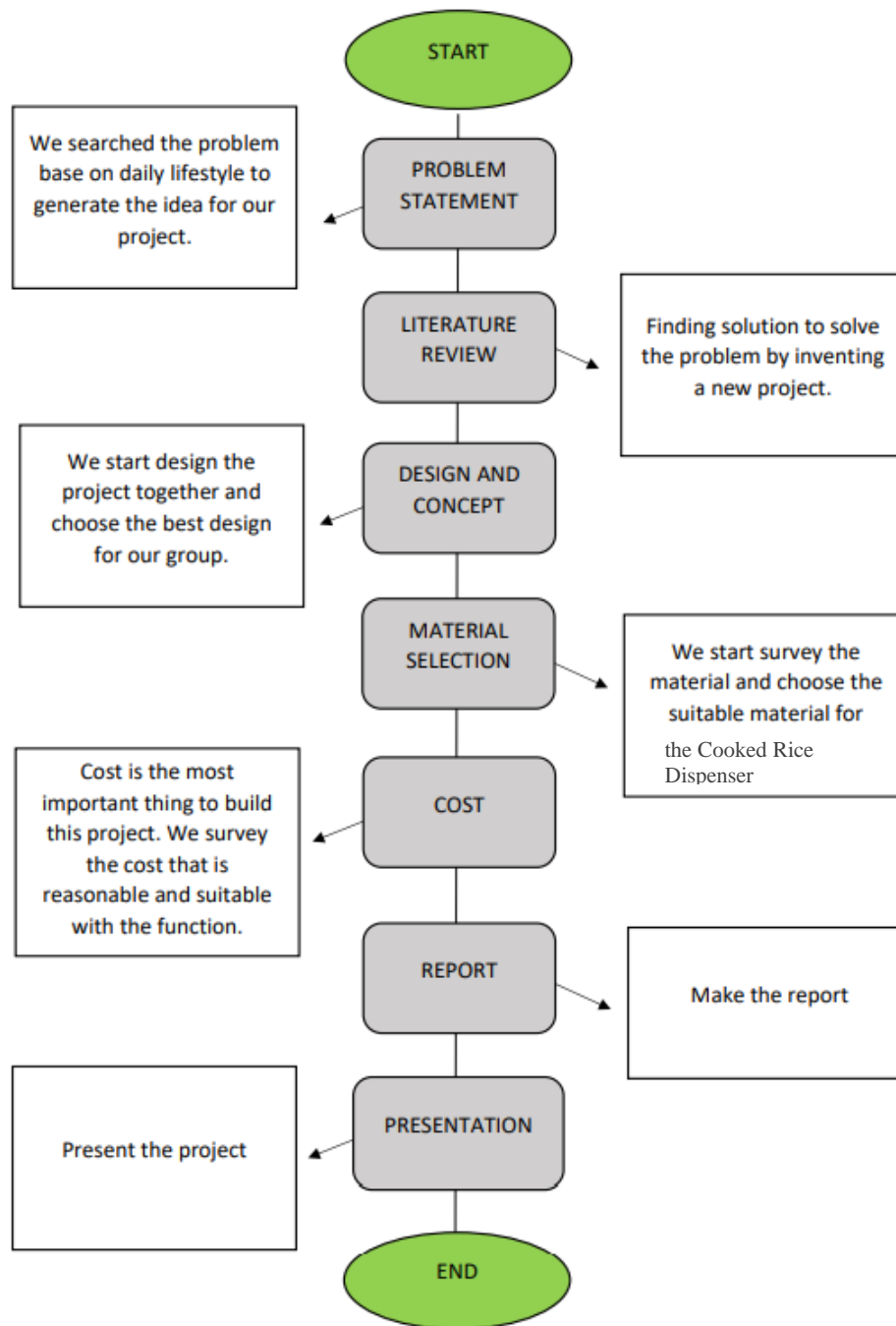

Figure 3.2: Project Flow Chart

3.2.1 FLOW CHART EXPLANATION

1) START

The key thing is to get started, which is the first step in anything. A successful start makes the rest of the project more manageable, and it establishes the groundwork for the project's completion. When anything ends, the conclusion is partially determined by how it began. Define and determine the project's core relevant aim, which will eventually lead to project success. The objectives will save time in the long term by speeding the entire project plan. Identify specific achievements, activities, and difficulties related with each objective, as well as a step-by-step action plan for achieving goals and overcoming barriers.

2) PRODUCT DESIGN

I. DESIGN BY FUSION



Figure 3.2.1.1: Cooked Rice Dispenser

II. ISOMETRIC VIEW

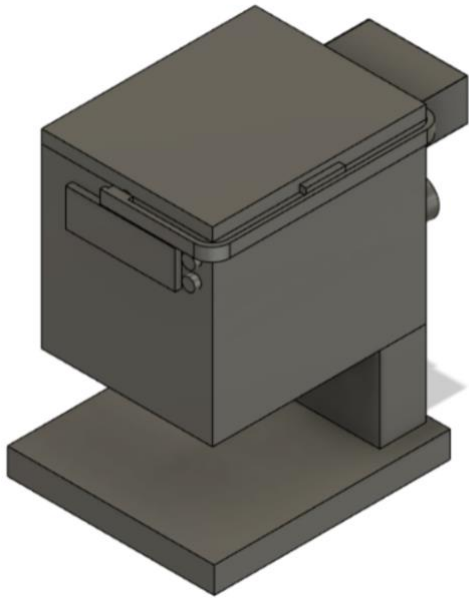

Figure 3.2.1.2

III. TOP VIEW

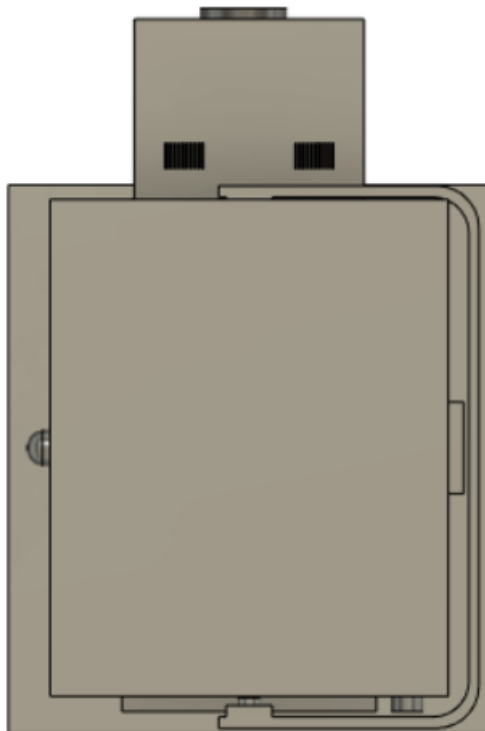

Figure 3.2.1.3

3.2.2 MATERIALS AND EQUIPMENT

The identification and prioritising of essential design requirements is the first step in material selection. Material selection is the act of selecting the best material to meet the specifications of a certain product. Mechanical qualities, physical features, and cost are only a few of the aspects that influence the selection requirements. The primary purpose of acquiring resources is to achieve the desired quantity at a fair price. As a result, it is critical to purchase raw materials at affordable costs.

1. Arduino UNO



Figure 3.2.2.1 (Arduino Uno)

2. 12v DC motor



Figure 3.2.2.2(Relay module)

3. Infrared sensor module

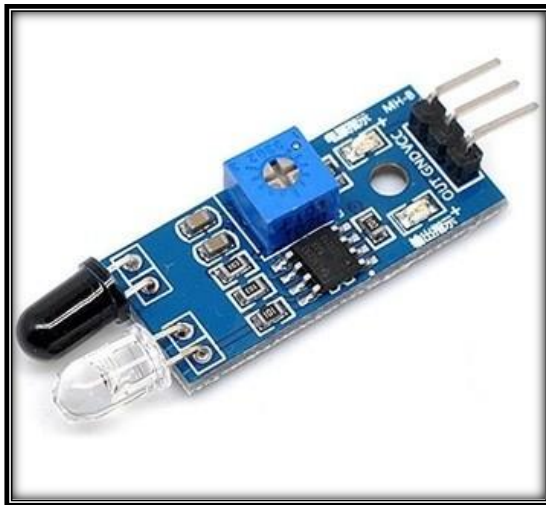

Figure 3.2.2.3 (Sensor soil moisture)

4. SG90 Micro Servo Motor



Figure 3.2.2.4 (Water pump)

5. Jumper Wire (M to M) (F to F)



Figure 3.2.2.5 (Jumper wire)

6. Rice container



Figure 3.2.2.6 (Rice container)

7. 3D printing

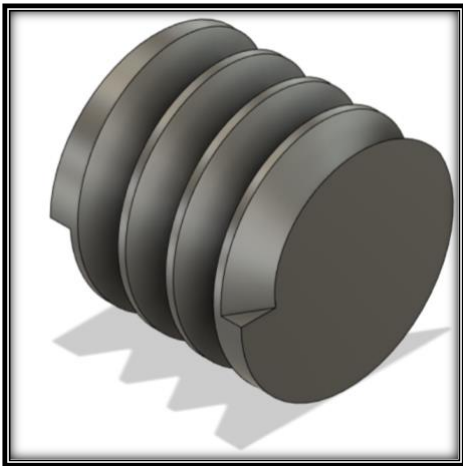

Figure 3.2.2.7 (3D printing spiral)

8. 3pin AC-DC Adapter



Figure 3.2.2.8 (Arduino Adapter)

9. Breadboards

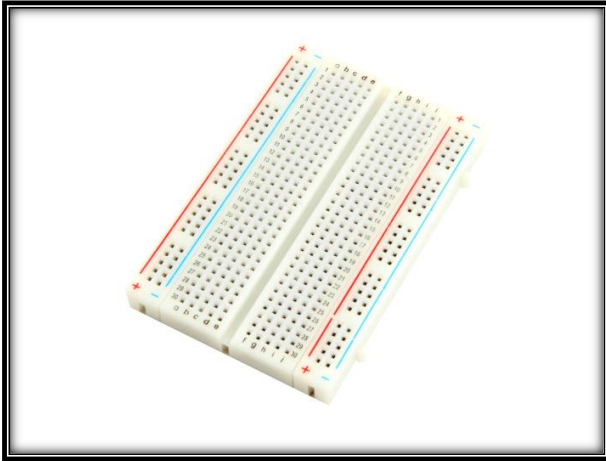

Figure 3.2.2.9 (Breadboard)

10. Stainless steel

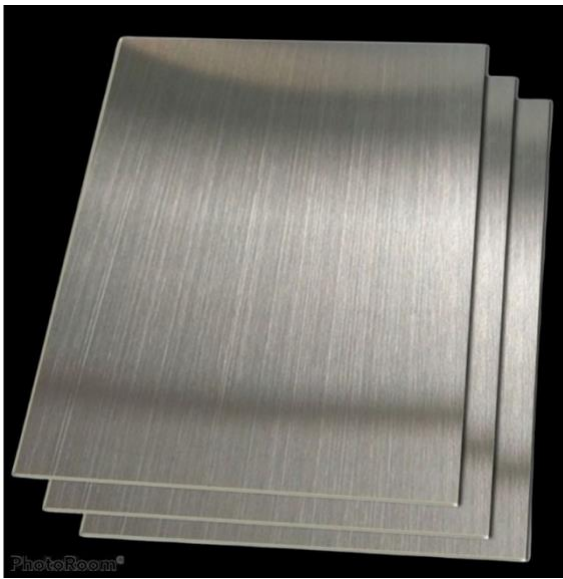

Figure 3.2.2.10 (Stainless steel)

11. LCD 1602



Figure 3.2.2.11 (LCD 1602)

3.3 BUDGET CALCULATIONS

Table above shows the cost of material used for this product.

| Numbers | Components | Price (RM) |
|----------------|-------------------------|-------------------|
| 1 | Arduino UNO | 50.00 |
| 2 | SG 90 Micro Servo Motor | 30.00 |
| 3 | 12v DC motor | 50.00 |
| 4 | Infrared sensor module | 5.00 |
| 5 | Jumper wire | 10.00 |
| 6 | Rice container | 40.00 |
| 7 | 3D printing spiral | 80.00 |
| 8 | Arduino adapter | 20.00 |
| 9 | Breadboard | 8.00 |
| 10 | Stainless steel | 40.00 |
| 11 | LCD1602 | 23.00 |
| | TOTAL | 356.00 |

3.4 PROGRAMMING APPLICATION

Arduino UNO is a low-cost, flexible, and easy-to-use programmable open-source microcontroller board that can be integrated into a variety of electronic projects. This board can be interfaced with other Arduino boards, Arduino shields, Raspberry Pi boards and can control relays, LEDs, servos, and motors as an output.

```
34 // include the library code:
35 #include <LiquidCrystal.h>
36 #include <Servo.h>
37
38 Servo myservo1; //creates a servo object
39 Servo myservo2; //creates a servo object
40
41 // initialize the library by associating any needed LCD interface pin
42 // with the arduino pin number it is connected to
43 const int rs = 12, en = 11, d4 = 5, d5 = 4, d6 = 3, d7 = 2;
44 LiquidCrystal lcd(rs, en, d4, d5, d6, d7);
45
46 int sensor = 6;
47 int A = 1;
48
49 void setup() {
50   // set up the LCD's number of columns and rows:
51   lcd.begin(20, 4);
52   // Print a message to the LCD.
53   lcd.print("LPV SDN BHD");
54   pinMode(sensor, INPUT);
55   myservo1.attach(9);
56   myservo2.attach(10);
57
58
59 void setup() {
60   // set up the LCD's number of columns and rows:
61   lcd.begin(20, 4);
62   // Print a message to the LCD.
63   lcd.print("LPV SDN BHD");
64   pinMode(sensor, INPUT);
65   myservo1.attach(9);
66   myservo2.attach(10);
67 }
68
69 void loop() {
70   int ir = digitalRead(sensor);
71
72   if (ir == 0) {
73     lcd.setCursor(15, 1);
74     lcd.print("open ");
75     if (A == 1) {
76       myservo1.write(0);
77       myservo2.write(100);
78       delay(5000);
79       myservo1.write(100);
80       myservo2.write(0);
81       A = 0;
82     }
83   }
84   if (ir == 1) {
85     lcd.setCursor(15, 1);
86     lcd.print("close");
87     myservo1.write(100);
88     myservo2.write(0);
89     A = 1;
90   }
91 }
```

3.5 CHAPTER SUMMARY

In conclusion, the design is important in producing a product. In this project, which is the Cooked Rice Dispenser, can be produced and manufactured without any problems. The materials used in this project are readily available commercially in the market as well as online. Besides, this product is also has ease of use due to its automatic movement. However, when exposed to damage in the electronic components and mechanical components, the product will not be able to run or operate smoothly or flawlessly.

CHAPTER 4

RESULTS

4.0 RESULTS

4.1 INTRODUCTION

For this chapter, all the ideas, data and analysis about Cooked Rice Dispensers were all previously combined. Data and analysis are very important in production of a product to achieve the project's goals. With this analysis done, it can bring new ideas and new innovations for the improvement and betterment of this product. After getting all the data that has been collected, each one of the data is analysed to produce a perfect product based on the results.

4.2 ADVANTAGES AND DISADVANTAGES

Every project has advantages and disadvantages. The benefit of this initiative is that it can be used not only in homes and for personal user, but also for commercial use in restaurants, buffets, food courts or other places that primarily serve food, importantly cooked rice.

However, the disadvantages or cons must be modified, fixed or corrected in the near future so that we will create a highly efficient and excellent product that is virtually unable to detect any shortcomings in the project. In every new product, there has to be specific features that need to be improved and fixed in order to increase the value of the product. As with all of the manufactured product, we must guarantee that the code placed into the Arduino, the wiring for the components and the capability of the motors and servos are appropriate and accurate. In the end, the most effective solution to the problems will be discovered and carried out.

4.3 ANALYSIS

Through a prepared questionnaire, data has been collected from multiple groups of people ranging from students, to restaurant owners. From the 50 questionnaires we gave out, we got back 24 responses and the following graphs shows the results obtained.

4.3.1 QUESTIONS

Below is the survey question we gave out to 50 people:

SURVEY ON COOKED RICE DISPENSER

NAME:

AGE:

GENDER:

OCCUPATION:

1. Do you have a rice cooker in house/canteen/shop?

YES / NO

2. Wasting time and energy while scooping the rice?

YES / NO

3. Insufficient space to keep the cooked rice?

YES / NO

4. Would you like to have a cooked rice dispenser your house/shop/canteen?

YES / NO

5. How would you like to control the cooked rice dispenser?

Sensor

Button

7. Would you like to have a cooked rice dispenser with stand or without stand?

With

Without

6. What's your price range for the cooked rice dispenser?

4.1.1.1 QUESTION 1

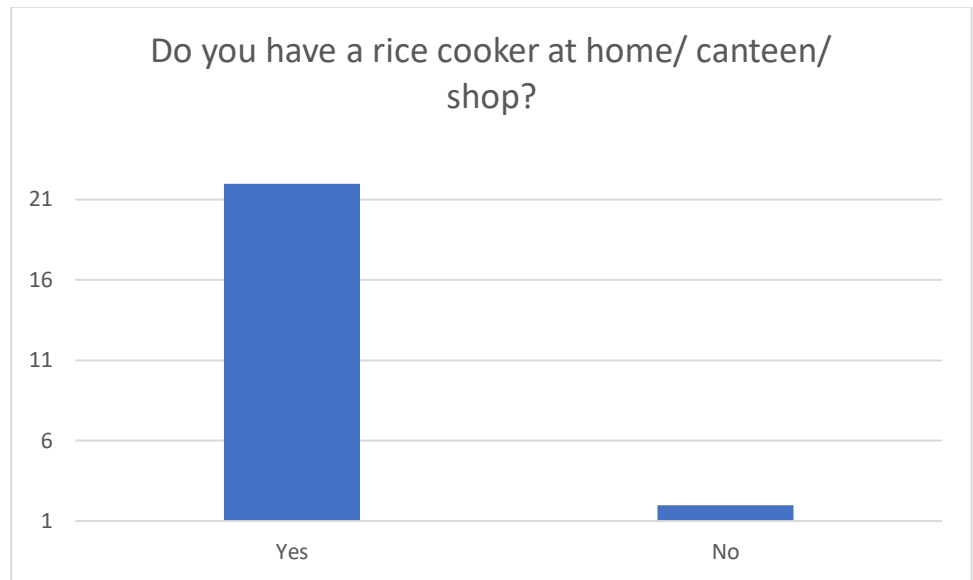

4.1.1.2 QUESTION 2

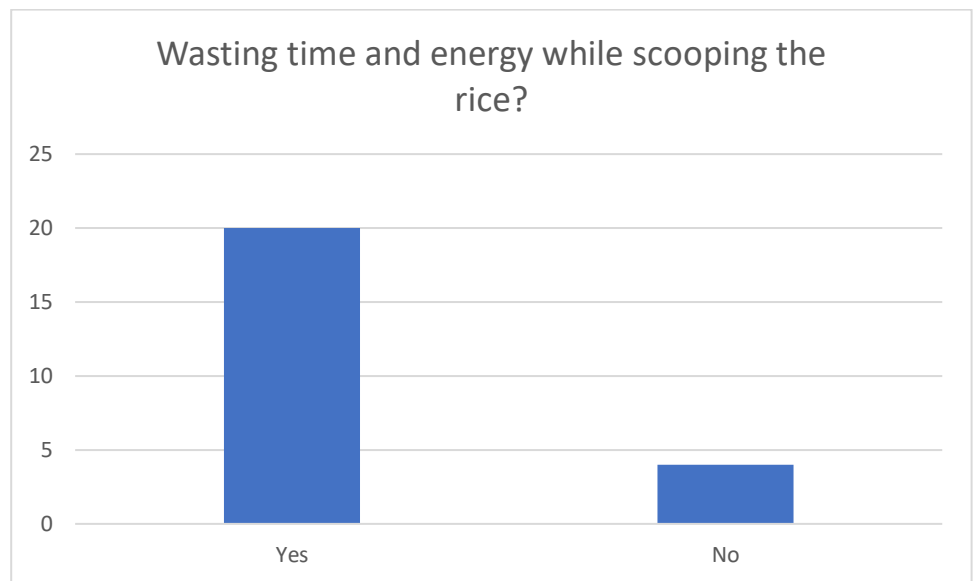

4.1.1.3 QUESTION 3

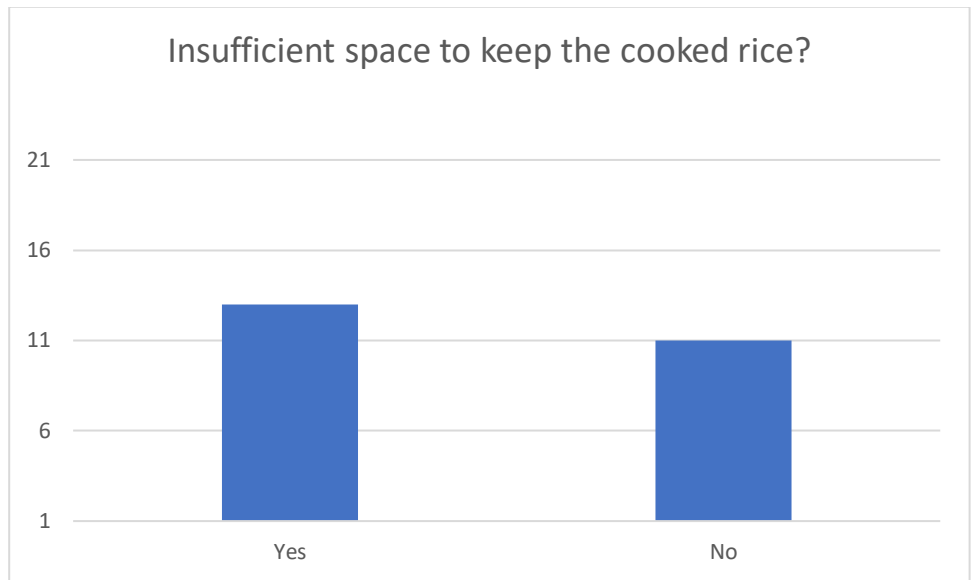

4.1.1.4 QUESTION 4

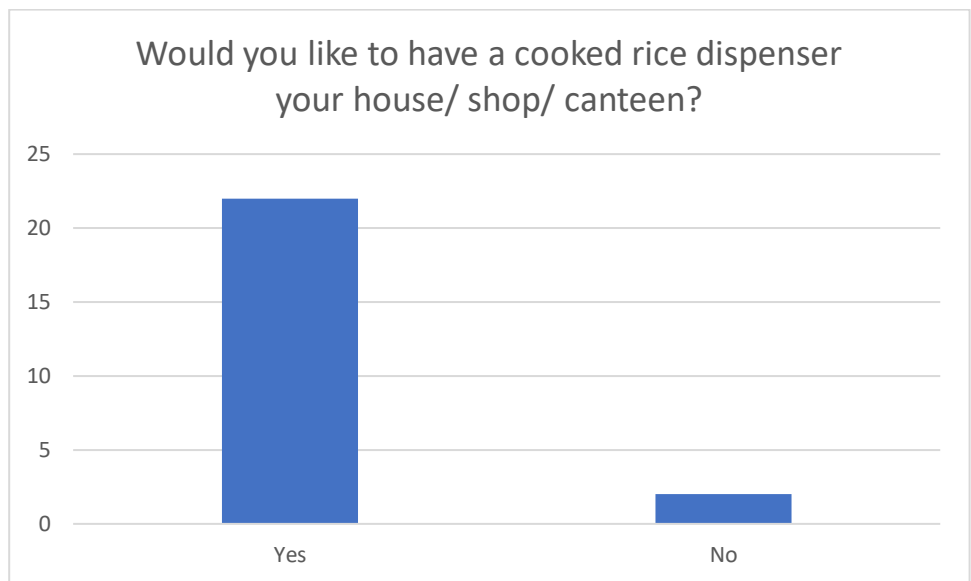

4.1.1.5 QUESTION 5

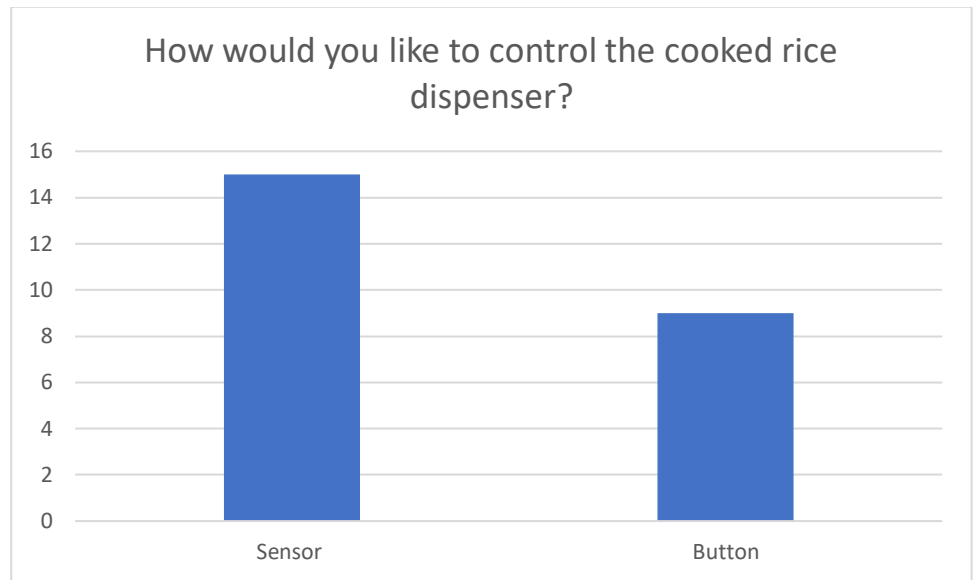

4.1.1.6 QUESTION 6

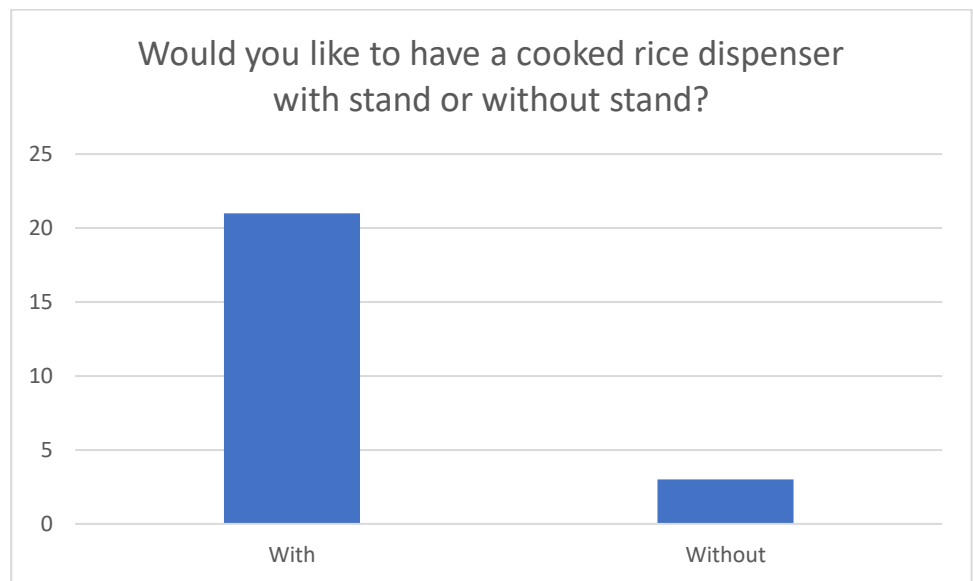

4.1.1.7 QUESTION 7

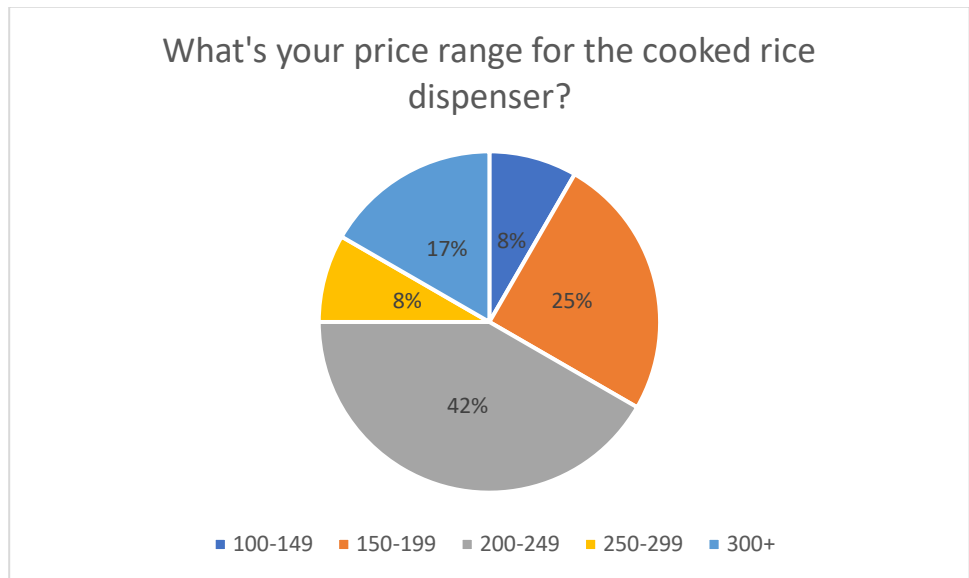

4.4 CHAPTER SUMMARY

In this chapter, we encounter all of the problem for our project, the Cooked Rice Dispenser. Naturally, we proceed to find the solutions to solve all the problems that has been encounter by our group. Not only that, our project also further encourages and enhances the level and usage of modern technology in the Food Service industry in Malaysia. The usage of microcontrollers (Internet of Things), electronic components and mechanical components shows that it can keep pace with the times and be in the same level of the technological development in other industries in our country. The improvement of the product will also be in the form of cost effectiveness to reduce the production cost to allow more people to be able to afford the product.

CHAPTER 5

DISCUSSION

5.0 DISCUSSION

5.1 INTRODUCTION

The conclusion allows for the last words on the issues and innovation that have been raised in the report paper to be presented. This is to demonstrate the importance of the project and product and also an opportunity to make an excellent final impression on a high note. The conclusion is also has intentions of helping anyone who reads the report to better understand the importance of the project after they complete reading the paper.

This part of the paper, which is Chapter 5, covers the conclusions for the entirety of the project. The conclusion will be ended with future recommendations and ideas for improvement for future improvement and innovation with a better result for the Cooked Rice Dispenser. In giving a good summary of the paper, the coming sections also present the discussion of the project and recommendations to improve overall quality of the project.

5.2 DISCUSSION

Throughout the development of the project, the product had been progressed from a rough draft to polished and working prototype of the product. Creativity was encouraged throughout the creation of this project when many ideas were executed or planned to be executed in a more affordable, user-friendly and with the usage of better materials and fabrication methods. The innovation of the Cooked Rice Dispenser with its relatively sleek design makes it more aesthetically pleasing and the mechanisms inside make sure the goal of dispensing rice efficiently is met.

The Cooked Rice Dispenser tested positively as it met the final goal of dispensing the rice efficiently. The ease of use was proven by the usage of the infrared sensor to detect a plate and dispense rice accordingly. The effectiveness of the mechanism inside the dispenser is also proven when it dispenses one plate of rice when the dispensing process starts and completes.

The project besides being useful in a home setting, also has a huge potential to be supplemented to the food service industry such as restaurants, canteens, buffets and others. Thus, advertising and commercialisation of the product is highly recommended to help spread the word out about the Cooked Rice Dispenser's availability in the market.

5.3 PROBLEM

In the execution and life cycle of any project, there is bound to be various unexpected problems and questions that may come up since every single project is unique, exclusive and different from another. Most importantly, the problems should be dealt with quickly and effectively.

- The container was proven to be not big enough to hold large quantities of rice. This brought up the issue of how many plates of rice can be served at a time before it is empty again and need to be filled up with cooked rice.
- The servo that held the doors in place wasn't strong enough to hold large quantities of rice. When filled with a lot of rice, the doors seemed to be getting pushed open by the rice.
- The rice would get cold when is kept inside the container for long periods of time. There was no way of keeping it warm for an extended period of time.
- The structure of the project wasn't strong enough to hold a heavy quantity of rice since it was held together mostly by hot glue.
- The visible structure, wiring, motor, and sensors made the product look untidy and messy.

5.4 RECOMMENDATION

Based on all the observations that were made and explanations that were offered, post completion of the Cooked Rice Dispenser, some suggestions to meet the product's requirements and satisfy a customer's needs were brought up. However, just increasing the features or the quality of the products is not the easiest task. After talking to the target audience, they helped the project and inspired us to take a more strategic approach towards the future development of our product. The common ways of improving a product are by improving existing features or adding new features to the product.

- Use a larger container for the cooked rice to hold increased amounts of rice. Thus, increasing the number of plates that could be served without needing to refill the container with more rice.
- Use stronger servos, paired with hinges for the doors to make them more rigid and stronger to hold a large and heavy quantity of cooked rice before failing.
- Add a heating coil or other heating elements like electrodes. This could be useful to help keep the rice warm for extended periods of time while it is filled up.
- Use stronger methods of bonding the materials together like welding, screws, rivets, hinges and other stronger and permanent methods to keep the structural strength and rigidity.
- Adopt better finishing touches like circuit boxes for the Arduino Uno and wires or build custom covers to conceal the motor to make the project seem cleaner.

5.5 CONCLUSION

When there is a plan for anything, it will never happen by itself. The process of developing a design into a product is not easy because of its various obstacles and problems that could be faced. Additionally, improving the students' skills while they spend their quality time learning and gaining new knowledge. The supervisor is the one that is responsible for monitoring this process and the progress of the students, all while pressuring the students to chase and progress all the overdue activities of the project.

This report has effectively documented the features, development, and the usage method of the Cooked Rice Dispenser as a way to improve efficiency in serving cooked rice. The design of the new Cooked Rice Dispenser is also in line with the integration of the learning framework of The Fourth Industrial Revolution by integrating the Internet of Things into the project.

As a conclusion, we found that our Cooked Rice Dispenser project reached the expectation we had when we first began brainstorming ideas. We managed to follow all the objectives we put in place. The main problem we faced is that the cooked rice would be difficult to dispense because of cooked rice that has different consistency and texture, so we managed to solve the problem using the knowledge we gained from our course. Based on our observations, our project is best suited for commercial use in a restaurant or buffet setting. The conventional way of serving rice in a commercial setting using a spoon is also considered slow, unhygienic, old-fashioned, and outdated. Therefore, all these issues are settled by the implementation of our Cooked Rice Dispenser since it overcomes all those issues. Eventually, we hope the product will create new market opportunities to sell and market the product to interested customers.

REFERENCES

- 1) <https://www.encyclopedia.com/food/encyclopedias-almanacs-transcripts-and-maps/natural-history-rice>
- 2) <https://www.suzumokikou.com/products/gst-fbb/>
- 3) <https://fujiseiki-international.com/portfolio-item/rice-dispenser/>
- 4) <https://www.youtube.com/watch?v=afVgy9naWhk>
- 5) <https://www.utoc.sg/rice-dispenser-rdr-600-b/>
- 6) https://en.wikipedia.org/wiki/History_of_rice_cultivation#:~:text=Rice%20was%20cultivated%20in%20the,as%20early%20as%207%2C000%20BP
- 7) <https://www.ucl.ac.uk/rice/history-rice/debating-origins-rice>
- 8) <https://iprice.my/kitchen-dining/storage/rice-dispensers/>
- 9) <https://create.arduino.cc/projecthub/akshayjoseph666/servo-motor-interface-with-arduino-uno-9693ad>
- 10) <https://create.arduino.cc/projecthub/ambhatt/ir-remote-controlled-dc-servo-motor-using-arduino-e41aff>
- 11) <https://arduinoprojek.wordpress.com/servo-with-ir-sensor/>
- 12) <https://ultimaker.com/learn/how-much-does-a-3d-printer-cost>
- 13) https://en.wikipedia.org/wiki/Arduino_Uno

APPENDIX



1)

Link for video of our working project that we built.

https://qrify.com/p/2Df4ZdK?utm_source=qrcode&utm_medium=video&utm_campaign=3095679



2)

During the Arduino Class to better learn about the coding for Arduino Uno.



3) Picture of our project during the PITEC presentation.